



KASTURBA GANDHI DEGREE & PG COLLEGE FOR WOMEN

(Sponsored & Managed jointly by Osmania Graduates' Association and The Exhibition Society, Hyderabad)

WEST MARREDPALLY, SECUNDERABAD, TELANGANA - 500026



YEAR OF PUBLICATION – 2019

S. No	Name of the teacher	Title of paper
1	V. Durga Nandini	Impact of diet and lifestyle factors on Hypertension
2	V. Durga Nandini	STRESS AND DIETARY APPROACH
3	Nahida Fatima	A Systematic Review - Update on Treatment of COVID -19
4	Dr. Annapurna Bhavani	Saline stress induced oxidative damage and adaptive response in sorghum genotypes
5	Dr. Annapurna Bhavani	Study of Growth, Sugars and water regulations in sorghum seedlings under salinity
6	Divya bharathi	A Cascaded Multilevel Inverter using THI Method for Electric Tractin Drive

PRINCIPAL
Kasturba Gandhi Degree & P.G. College
For Women, Marredpally,
SECUNDERABAD.



Bookmark Us

Press **Ctrl + D** Now!

Quick Links

- > [Current Issue \(May 2023\)](#)
- > [Article Processing Charge](#)
- > [Submit Your Article](#)
- > [Final Submission](#)
- > [Search Published Articles](#)
- > [Researcher's Guide](#)
- > [Recent Publications](#)
- > [Recent e-Presentations](#)

UGC Notification

[Peer-Reviewed Journal](#)

Qualis-CAPES (Class C)

[Class C in Qualis-CAPES](#)

Member's Area

- > [Member Sign In](#)
- > [Get Registered](#)

Impact Factor

- > [SJIF 2022: 7.942](#)

Join Us

- > [Join IJSR YouTube Channel](#)

Indexing

- > [Google Scholar](#)
- > [CrossRef Member](#)
- > [CiteFactor](#)
- > [e-Library.ru Index](#)
- > [ScienceGate Index](#)
- > [Scite Index](#)
- > [Digital Repository Index](#)
- > [Noel Meorial Library Index](#)
- > [Academia.Edu Index](#)

Decathlon: Shop From 70+ Sports And 500 Products with a 2 Year Warranty. Shop Now

Article of the Month

Downloads: **402** | Views: **447** | Weekly Hits: **1** | Monthly Hits: **2**

Cardiology Science, Azerbaijan, Volume 8 Issue 12, December 2019

Innovations in the Diagnosis and Treatment of Chronic Heart Failure

Eyubova U. A., Bakhshiyev M. M



Share this article

Volume 8 Issue 12, December 2019

[Next Page](#)

[Last Page](#)

Downloads: **128** | Views: **159** | Weekly Hits: **1** | Monthly Hits: **2**

Medicine Science, India, Volume 8 Issue 12, December 2019

Study on Epidemiology, Etiology, Pathology, Pathogenesis, Mode of Presentation and Clinical Features of Osteoarthritis Joints from Cases Who are Attending Tertiary Care Hospital

[Samikrishnan Perumal](#) ^[3] | Saravanan Mayilsamy | [Senthakrishna Thangaraj](#) ^[3]



Share this article

Downloads: **402** | Views: **447** | Weekly Hits: **1** | Monthly Hits: **2**

Cardiology Science, Azerbaijan, Volume 8 Issue 12, December 2019

Innovations in the Diagnosis and Treatment of Chronic Heart Failure

Eyubova U. A. | Bakhshiyev M. M



Share this article

Downloads: **243** | Views: **276** | Weekly Hits: **1** | Monthly Hits: **2**

Marketing, Georgia, Volume 8 Issue 12, December 2019

Marketing Investigation of the Behavior of Tourists in Georgia

Babilua P. | Maglakelidze K.



Share this article

Downloads: **211** | Views: **242** | Weekly Hits: **1** | Monthly Hits: **2**

Medical Surgical, India, Volume 8 Issue 12, December 2019

Mesentric Cyst: A Rare Intra-Abdominal Tumor

[Dr. Kamlesh Galani](#) ^[3] | Dr. Aneri Rathod | Dr. Ankur Modi | Dr. Digvijaysinh Sindhav



Share this article

Downloads: **211** | Views: **244** | Weekly Hits: **1** | Monthly Hits: **2**

Environmental Science Studies, Nigeria, Volume 8 Issue 12, December 2019

Risk Assessment of Heavy Metals in Soil and Vegetables of Selected Dumpsites in Port-Harcourt Metropolis

Onwugbuta N | [Anaero-Nweke G. N.](#) ^[3] | [Ekweozor I. K. E.](#) ^[3] | Ubong I. U



Share this article

Decathlon: Shop From 70+ Sports And 5000+ Products with a 2 Year Warranty. Shop Now

Downloads: **193** | Views: **231** | Weekly Hits: **1** | Monthly Hits: **2**

Biological Sciences, Saudi Arabia, Volume 8 Issue 12, December 2019

Isolation and Characterization of Post-Harvest Fungal Species and Pathogenicity Assessment of Spoilt Fruits Sold in Sai Market

Ahmed R. Al-Najada



Share this article (

Downloads: **177** | Views: **212** | Weekly Hits: **1** | Monthly Hits: **2**

Dermatology, India, Volume 8 Issue 12, December 2019

Prospective Cross-Sectional Clinical Study of Autoimmune Connective Tissue Diseases in Pediatric Age Group in Tertiary HospitalDr Sneha Patel | Dr Priya Kariya | [Dr Krina Patel](#) ^[3]

Share this article (

Downloads: **195** | Views: **226** | Weekly Hits: **1** | Monthly Hits: **2**

Biological Engineering, India, Volume 8 Issue 12, December 2019

Combining Studies on Preparation of Metal Nanoparticles from Plant Extracts as Nano-AntibioticShivani Kushwaha | Dr. Jaya Singh Bisen | [Pragya Srivastava](#) ^[2]

Share this article (

Downloads: **186** | Views: **224** | Weekly Hits: **1** | Monthly Hits: **2**

Biological Engineering, Uzbekistan, Volume 8 Issue 12, December 2019

Distributed Species of Family Liliaceae and Iridaceae in Tarkapchigai Botanical-Geographical Region (Uzbekistan)

Azizbek S. Abduraimov | Sultankul A. Daniyarov



Share this article (

Downloads: **162** | Views: **200** | Weekly Hits: **1** | Monthly Hits: **2**

Ichthyology Science, Uzbekistan, Volume 8 Issue 12, December 2019

Characteristic of Aquatic Biocenosis of the Talimardjan Reservoir in Uzbekistan

Ismailov Kh. | Yuldashov M.A. | Kamilov B.G.



Share this article (

Decathlon: Shop From 70+ Sports And 5000+ Products with a 2 Year Warranty. Shop Now

[Next Page](#)[Last Page](#)

Decathlon: Shop From 70+ Sports And 500 Products with a 2 Year Warranty. Shop Now



Content Links

[Feedback](#)[Join Us](#)[Privacy Policy](#)

Contact Us

International Journal of Science and Research (IJSR)

Email: editor.ijsrnet@gmail.com

Connect

Facebook

LinkedIn

Twitter

Creative Commons: CC-BY | Open Access

© 2012-2023 International Journal of Science and Research (IJSR) - All Rights Reserved.

The Source Code and Contents of this Website are protected by Copyright Laws and May Not Be Reproduced, Distributed, or Transmitted in Any Form or by Any Means without the Prior Written Permission of International Journal of Science and Research (IJSR). Unauthorized Copying, Reproduction, Distribution, or Transmission of this Website's Source Code and Contents is Strictly Prohibited and May Result in Severe Legal Action.



ISSN –2321-3043 ANNQUEST

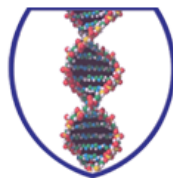

ST. ANN'S COLLEGE FOR WOMEN

[Home](#)
[About Us](#)
[Categories](#)
[Announcements](#)
[Guidelines](#)
[Archives](#)
[Editorial Board](#)
[Current Issue](#)
ANNSCOPE

Latest Update News

Welcome to St. Ann's Journal Online:

Editorial Board Members

Annquest is an online journal initiated by St. Ann's College for Women Mehdiapatnam, Hyderabad that provides publication of articles in all disciplines of pure and applied sciences, social sciences and humanities. The journal manifests our vision to stimulate intellectual activity, to build the collective knowledge base and to provide the portal to record and disseminate the thoughts and perspective of scholars and academicians.

Annquest Journal
Editorial Members and Their Details 2020-21

S.No	Name	Contact No.	Mail. ID	Department/Organization
1	Dr.Sr.P.Amrutha	8008161972	mailto:amrutha_nov5@rediffmail.com	Principal St.Anns college for women, Mehdiapatnam,Hyderabad
2	Dr.V.Venogopal Rao	99850 65518	rao5749@gmail.com	Department of Genetics , St.Anns college for women, Mehdiapatnam,Hyderabad
3	Dr.Tabassum	9059307869	Tabassum5550@gmail.com	DL.Department of zoology. Telangana Social Welfare Residential Degree College For Women, Armoor, Nizamabad
4	Mrs.P.V.Neeraja	9490748289	pvneeraja18@gmail.com	Department of Botany, St.Anns College for Women,Mehdiapatnam,Hyderabad
5	Dr.Swapna	87900 17061	swapna.nagalingam@gmail.com	Department of Genetics , St.Anns college for women, Mehdiapatnam,Hyderabad



6	Mrs.N.Sushma	8790716558	sushmasrinivasreddy87@gmail.com	Department of Biotechnology , St.Anns college for women, Mehdipatnam,Hyderabad
7	Ms.Meeta Joshi	9848841133	jmeeta02@gmail.com	Department of History , St.Anns college for women, Mehdipatnam,Hyderabad
8	Dr.Archana jha	9640170434	jhaarchana18@gmail.com	Department of Hindi , St.Anns college for women, Mehdipatnam,Hyderabad
9	Ms.Prashanthi	73967 60834	shanthikopuri@gmail.com	Department of MCA , St.Anns college for women, Mehdipatnam,Hyderabad



ISSN –2321-3043 ANNQUEST

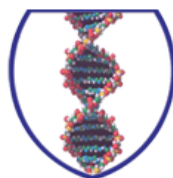

ST. ANN'S COLLEGE FOR WOMEN

[Home](#)
[About Us](#)
[Categories](#)
[Announcements](#)
[Guidelines](#)
[Archives](#)
[Editorial Board](#)
[Current Issue](#)
[ANNSCOPE](#)

Humanities

Social Science













Physical Science

Lifesciences

archives

Latest Update News

S.No	Title & Authors Name	Year of Publishing	Page No	Downloads
1	AN OVERVIEW OF A RECENT DEVELOPMENT IN ELECTROCHEMICAL NCOVID-19 DETECTION BIOSENSOR	2019	1-9	
2	EXPERIENCING COVID-19 FROM PAST TO PRESENT / OVERLOOKED COVID ON A SURGE	2019	1-9	
3	DEVELOPMENT IN DIAGNOSTICS KIT AND DIAGNOSTIC METHODS FOR TESTING OF COVID-19	2019	1-7	
4	CLINICAL FINDING'S WITH REFERENCE TO COVID-19	2019	1-13	
5	CORONA VIRUS AND ITS MORPHOLOGY	2019	1-6	
6	STRUCTURAL DESIGN AND DIVERSITY OF COVID-19	2019	1-6	
7	SCRUTINIZING MEASURES TO CONTROL THE SPREAD OF COVID-19	2019	1-4	
8	AN ANALYSIS – STRUCTURAL DESIGN AND DIVERSITY OF CORONA VIRUS(COV-19)	2019	1-4	
9	STRUCTURAL DESIGN OF CORONA VIRUS AND ITS DIVERSITY	2019	1-9	
10	CLINICAL FINDINGS OF COVID-19 PANDEMIC:A BRIEF REVIEW	2019	1-8	
11	A SYSTEMIC REVIEW - UPDATE ON TREATMENT OF COVID-19	2019	1-7	
12	BRIEF INSIGHT ON THE PLAUSIBLE SYNTHESIS OF HYDROXYCHLOROQUINE DURING SPREAD OF COVID-19	2019	1-10	

13	A MATHEMATICAL APPROACH TOWARDS THE ONSET OF PANDEMIC COVID-19 AND PREVENTIVE MEASURES	2019	1-6	
14	COVID-19 PANDEMIC - AN OVERVIEW AND FUTURE PERSPECTIVE	2019	1-10	
15	VACCINE TRIALS IN A NUTSHELL FOR NOVEL CORONA VIRUS	2019	1-10	
16	OUTBREAK OF CORONA VIRUS-19 : A REVIEW OF LIFECYCLE, CLINICAL FINDINGS AND TREATMENT METHODS	2019	1-5	
17	PREVALENCE OF VITAMIN B12 AMONG INDIAN POPULATIONS	2019	1-19	
18	AN OVERVIEW ON STUDY OF TRANS FATTY ACIDS	2018	1-11	
19	STRESS AND DIETARY APPROACH	2018	1-19	
20	VITAMIN D DEFICIENCY	2018	1-13	
21	Probability distribution of children according to sex in a random population of families - Haritha Myakala, Dr.V.Venugopal Rao, T.Reshma Rao , M.Divya Jyothi	2018		
22	Genetic risks of Alzheimer's disease - A Case Study - Myakala Haritha, Dr. N. Swapna, Dr.V.Venugopal Rao	2018		
23	A Review on Ecological importance of Estuarine Fishes - Deepthimahanthi Divya	2017		
24	Fungal Secondary Metabolites As Herbicides And Antibiotics - Sadaf Kalam, A M Sylaja	2017		
25	Leigh syndrome - A Rare Genetic Disorder - Salwa Hareem, Dr. N Swapna , Dr. V. Venugopal Rao	2017		
26	Plant Growth Promoting Rhizobacteria (PGPR): Ecofriendly alternatives for sustainable agriculture - Sadaf Kalam, A M Sylaja	2017		
27	Spatial Mining - Issues and Challenges - Aparna Bulusu	2017		
28	Anand Paper - IEEE format	2017	1-7	
29	BMI Paper- IEEE format	2017	1-6	
30	Chitra- IEEE format	2017	1-9	
31	Sneha IEEE paper	2017	1-3	
32	Thyroid paper	2017	1-6	
33	Characterisation of Biomaterials and their Medicinal Applications	2017	1-6	

34	Phytochemical investigations of Momordica charantia (L.) and Momordica dioica (Roxb).root extracts	2016	7-15	
35	The study of effectiveness of Computer assisted learning material for content based instruction in improving reading skill.	2016	16-19	
36	Affordable Luxury or Liability- The Internet of Things	2016	20-24	
37	Epidermolysis Bullosa Simplex: A Case Report with two Affected Sibs in a Family	2016	25-28	
38	OptimizedSolarStreetControl	2016	1-4	
39	StrategicIoT	2015	5-12	
40	SmartCards	2015	13-18	
41	AmbientIntelligentIoT	2015	19-23	
42	StudyOfIoT	2015	24-28	
43	Nanotoxicology	2015	29-33	
44	WearableEmbeddedSystems	2015	34-38	
45	Machinelearning	2015	39-42	
46	ThirdPlatform	2015	43-48	
47	WebSecurityHarbinger	2015	49-63	
48	Data Analytics for 0-6 Sex Ratio – Census 2001 (Telangana and Andhra Pradesh States). V.V. Hara Gopal	2015	1-17	
49	Comparison between the Local Growth References of Indian preschool children aged 0-36 months and WHO child growth standards, 2006 Ch. Lakshmi Sujatha & M. Vishnu Vardhana Rao	2014	18-31	
50	Urbanization- Impact on prevalence of Diabetes in India Meena Kumari	2014	32-43	
51	Demographic Transition in India-Issues, Challenges and the Way Ahead Mrs. Jaimole Cross, Mrs. Ratna Srinivasan	2014	44-49	
52	Fertility trends, timing and postponement V.Sai Sri Kishore, Amala Bharath G S	2014	50-57	
53	Study of livestock population dynamics in india Sneha Saha, K.P. Suresh KP, G.B. Manjunathareddy and H. Rahman	2014	58-61	
54	Causes of Internal Migration in India and Its Effects A.Usha Rani	2014	62-69	

55	Causes and consequences of migration G Ramaa Deepthi, M Bhavana	2014	70-78	
56	Population change and Development in India Suneetha Esampalli	2014	79-85	
57	Demographic issues and analysis R.Manasa	2014	86-91	
58	High frequency somatic embryogenesis and plantlet regeneration from shoot tip explants of Soy bean (Glycine max L.) Merr.	2014	1-8	
59	Role of Nutrition and Balanced Diet in Enhancing Sports Performance	2014	9-22	
60	స్త్రీ - సాంఘికన్యాయము-మనుస్మృతి,కాండీన్యస్మృతుల యొక్క తులనాత్మక అధ్యయనము డా. కె. ప్రభావతి	2014	23-30	
61	తెలుగు దినపత్రికలు-సాహిత్య సేవ డాక్టర్.అద్దంకిసుబ్బలక్ష్మి	2014	31-36	
62	A comparative study of Traditional shopping Vs Online shopping K.Sree Latha Reddy and S.JayaLaxmi	2014	37-51	
63	SYNERGIES OF E-COMMERCE JVR Geetanjali and P.Srinivasa	2014	52-60	
64	Environmental Accounting – A case study of cement sector in India T.Anuradha	2014	61-82	
65	व्यक्तित्व विकास में बाल साहित्य की भूमिका	2014	83-86	
66	Effect of Colchicine on mitosis of the onion root tips (Allium cepa) (Induction of polyloidy). Varsha Uma Eswaran, V. Venugopal Rao and Lakshmi Rajgopal	2014		
67	HUMANVALUES IN ATHARVAVEDA K.Prabhavathi	2014		
68	Invitro Rooting efficiency in Morus indica cultivars (S34, S54, M5 and Mysore-local) from invitro shoot cultures Lavanya Kakarla and Chakravarthy Rama	2013		
69	Effect of Colchicine on mitosis of the onion root tips (Allium cepa) (Induction of polyloidy). Varsha Uma Eswaran, V. Venugopal Rao and Lakshmi Rajgopal	2012		



ISSN –2321-3043 ANNQUEST

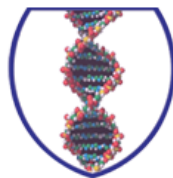

ST. ANN'S COLLEGE FOR WOMEN

[Home](#)
[About Us](#)
[Categories](#)
[Announcements](#)
[Guidelines](#)
[Archives](#)
[Editorial Board](#)
[Current Issue](#)
ANNSCOPE

Latest Update News

Welcome to St. Ann's Journal Online:

Editorial Board Members

Annquest is an online journal initiated by St. Ann's College for Women Mehdiapatnam, Hyderabad that provides publication of articles in all disciplines of pure and applied sciences, social sciences and humanities. The journal manifests our vision to stimulate intellectual activity, to build the collective knowledge base and to provide the portal to record and disseminate the thoughts and perspective of scholars and academicians.

Annquest Journal

Editorial Members and Their Details 2020-21

S.No	Name	Contact No.	Mail. ID	Department/Organization
1	Dr.Sr.P.Amrutha	8008161972	mailto:amrutha_nov5@rediffmail.com	Principal St.Anns college for women, Mehdiapatnam,Hyderabad
2	Dr.V.Venogopal Rao	99850 65518	rao5749@gmail.com	Department of Genetics , St.Anns college for women, Mehdiapatnam,Hyderabad
3	Dr.Tabassum	9059307869	Tabassum5550@gmail.com	DL.Department of zoology. Telangana Social Welfare Residential Degree College For Women, Armoor, Nizamabad
4	Mrs.P.V.Neeraja	9490748289	pvneeraja18@gmail.com	Department of Botany, St.Anns College for Women,Mehdiapatnam,Hyderabad
5	Dr.Swapna	87900 17061	swapna.nagalingam@gmail.com	Department of Genetics , St.Anns college for women, Mehdiapatnam,Hyderabad



6	Mrs.N.Sushma	8790716558	sushmasrinivasreddy87@gmail.com	Department of Biotechnology , St.Anns college for women, Mehdipatnam,Hyderabad
7	Ms.Meeta Joshi	9848841133	jmeeta02@gmail.com	Department of History , St.Anns college for women, Mehdipatnam,Hyderabad
8	Dr.Archana jha	9640170434	jhaarchana18@gmail.com	Department of Hindi , St.Anns college for women, Mehdipatnam,Hyderabad
9	Ms.Prashanthi	73967 60834	shanthikopuri@gmail.com	Department of MCA , St.Anns college for women, Mehdipatnam,Hyderabad



ISSN –2321-3043 ANNQUEST

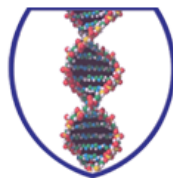

ST. ANN'S COLLEGE FOR WOMEN

[Home](#)
[About Us](#)
[Categories](#)
[Announcements](#)
[Guidelines](#)
[Archives](#)
[Editorial Board](#)
[Current Issue](#)
[ANNSCOPE](#)

[Humanities](#)

[Social Science](#)

















[Physical Science](#)

[Lifesciences](#)

archives

Latest Update News

S.No	Title & Authors Name	Year of Publishing	Page No	Downloads
1	AN OVERVIEW OF A RECENT DEVELOPMENT IN ELECTROCHEMICAL NCOVID-19 DETECTION BIOSENSOR	2019	1-9	
2	EXPERIENCING COVID-19 FROM PAST TO PRESENT / OVERLOOKED COVID ON A SURGE	2019	1-9	
3	DEVELOPMENT IN DIAGNOSTICS KIT AND DIAGNOSTIC METHODS FOR TESTING OF COVID-19	2019	1-7	
4	CLINICAL FINDING'S WITH REFERENCE TO COVID-19	2019	1-13	
5	CORONA VIRUS AND ITS MORPHOLOGY	2019	1-6	
6	STRUCTURAL DESIGN AND DIVERSITY OF COVID-19	2019	1-6	
7	SCRUTINIZING MEASURES TO CONTROL THE SPREAD OF COVID-19	2019	1-4	
8	AN ANALYSIS – STRUCTURAL DESIGN AND DIVERSITY OF CORONA VIRUS(COV-19)	2019	1-4	
9	STRUCTURAL DESIGN OF CORONA VIRUS AND ITS DIVERSITY	2019	1-9	
10	CLINICAL FINDINGS OF COVID-19 PANDEMIC:A BRIEF REVIEW	2019	1-8	
11	A SYSTEMIC REVIEW - UPDATE ON TREATMENT OF COVID-19	2019	1-7	
12	BRIEF INSIGHT ON THE PLAUSIBLE SYNTHESIS OF HYDROXYCHLOROQUINE DURING SPREAD OF COVID-19	2019	1-10	

13	A MATHEMATICAL APPROACH TOWARDS THE ONSET OF PANDEMIC COVID-19 AND PREVENTIVE MEASURES	2019	1-6	
14	COVID-19 PANDEMIC - AN OVERVIEW AND FUTURE PERSPECTIVE	2019	1-10	
15	VACCINE TRIALS IN A NUTSHELL FOR NOVEL CORONA VIRUS	2019	1-10	
16	OUTBREAK OF CORONA VIRUS-19 : A REVIEW OF LIFECYCLE, CLINICAL FINDINGS AND TREATMENT METHODS	2019	1-5	
17	PREVALENCE OF VITAMIN B12 AMONG INDIAN POPULATIONS	2019	1-19	
18	AN OVERVIEW ON STUDY OF TRANS FATTY ACIDS	2018	1-11	
19	STRESS AND DIETARY APPROACH	2018	1-19	
20	VITAMIN D DEFICIENCY	2018	1-13	
21	Probability distribution of children according to sex in a random population of families - Haritha Myakala, Dr.V.Venugopal Rao, T.Reshma Rao , M.Divya Jyothi	2018		
22	Genetic risks of Alzheimer's disease - A Case Study - Myakala Haritha, Dr. N. Swapna, Dr.V.Venugopal Rao	2018		
23	A Review on Ecological importance of Estuarine Fishes - Deepthimahanthi Divya	2017		
24	Fungal Secondary Metabolites As Herbicides And Antibiotics - Sadaf Kalam, A M Sylaja	2017		
25	Leigh syndrome - A Rare Genetic Disorder - Salwa Hareem, Dr. N Swapna , Dr. V. Venugopal Rao	2017		
26	Plant Growth Promoting Rhizobacteria (PGPR): Ecofriendly alternatives for sustainable agriculture - Sadaf Kalam, A M Sylaja	2017		
27	Spatial Mining - Issues and Challenges - Aparna Bulusu	2017		
28	Anand Paper - IEEE format	2017	1-7	
29	BMI Paper- IEEE format	2017	1-6	
30	Chitra- IEEE format	2017	1-9	
31	Sneha IEEE paper	2017	1-3	
32	Thyroid paper	2017	1-6	
33	Characterisation of Biomaterials and their Medicinal Applications	2017	1-6	

34	Phytochemical investigations of Momordica charantia (L.) and Momordica dioica (Roxb).root extracts	2016	7-15	
35	The study of effectiveness of Computer assisted learning material for content based instruction in improving reading skill.	2016	16-19	
36	Affordable Luxury or Liability- The Internet of Things	2016	20-24	
37	Epidermolysis Bullosa Simplex: A Case Report with two Affected Sibs in a Family	2016	25-28	
38	OptimizedSolarStreetControl	2016	1-4	
39	StrategicIoT	2015	5-12	
40	SmartCards	2015	13-18	
41	AmbientIntelligentIoT	2015	19-23	
42	StudyOfIoT	2015	24-28	
43	Nanotoxicology	2015	29-33	
44	WearableEmbeddedSystems	2015	34-38	
45	Machinelearning	2015	39-42	
46	ThirdPlatform	2015	43-48	
47	WebSecurityHarbinger	2015	49-63	
48	Data Analytics for 0-6 Sex Ratio – Census 2001 (Telangana and Andhra Pradesh States). V.V. Hara Gopal	2015	1-17	
49	Comparison between the Local Growth References of Indian preschool children aged 0-36 months and WHO child growth standards, 2006 Ch. Lakshmi Sujatha & M. Vishnu Vardhana Rao	2014	18-31	
50	Urbanization- Impact on prevalence of Diabetes in India Meena Kumari	2014	32-43	
51	Demographic Transition in India-Issues, Challenges and the Way Ahead Mrs. Jaimole Cross, Mrs. Ratna Srinivasan	2014	44-49	
52	Fertility trends, timing and postponement V.Sai Sri Kishore, Amala Bharath G S	2014	50-57	
53	Study of livestock population dynamics in india Sneha Saha, K.P. Suresh KP, G.B. Manjunathareddy and H. Rahman	2014	58-61	
54	Causes of Internal Migration in India and Its Effects A.Usha Rani	2014	62-69	

55	Causes and consequences of migration G Ramaa Deepthi, M Bhavana	2014	70-78	
56	Population change and Development in India Suneetha Esampalli	2014	79-85	
57	Demographic issues and analysis R.Manasa	2014	86-91	
58	High frequency somatic embryogenesis and plantlet regeneration from shoot tip explants of Soy bean (Glycine max L.) Merr.	2014	1-8	
59	Role of Nutrition and Balanced Diet in Enhancing Sports Performance	2014	9-22	
60	స్త్రీ - సాంఘికన్యాయము-మనుస్మృతి,కాండీన్యస్మృతుల యొక్క తులనాత్మక అధ్యయనము డా. కె. ప్రభావతి	2014	23-30	
61	తెలుగు దినపత్రికలు-సాహిత్య సేవ డాక్టర్.అద్దంకిసుబ్బలక్ష్మి	2014	31-36	
62	A comparative study of Traditional shopping Vs Online shopping K.Sree Latha Reddy and S.JayaLaxmi	2014	37-51	
63	SYNERGIES OF E-COMMERCE JVR Geetanjali and P.Srinivasa	2014	52-60	
64	Environmental Accounting – A case study of cement sector in India T.Anuradha	2014	61-82	
65	व्यक्तित्व विकास में बाल साहित्य की भूमिका	2014	83-86	
66	Effect of Colchicine on mitosis of the onion root tips (Allium cepa) (Induction of polyloidy). Varsha Uma Eswaran, V. Venugopal Rao and Lakshmi Rajgopal	2014		
67	HUMANVALUES IN ATHARVAVEDA K.Prabhavathi	2014		
68	Invitro Rooting efficiency in Morus indica cultivars (S34, S54, M5 and Mysore-local) from invitro shoot cultures Lavanya Kakarla and Chakravarthy Rama	2013		
69	Effect of Colchicine on mitosis of the onion root tips (Allium cepa) (Induction of polyloidy). Varsha Uma Eswaran, V. Venugopal Rao and Lakshmi Rajgopal	2012		

🔔 How start New Journal & software (<http://ijrar.org/How to start new journal & journal supporting software.php>)

Book & Thesis Publications (<http://ijrar.org/bookpub.php>) IJRAR is Peer Review Refereed Open access

Monthly, Multidisciplinary, Multilanguage Online, Print Journal



(<https://www.ijrar.org>)

INTERNATIONAL JOURNAL OF RESEARCH AND ANALYTICAL REVIEWS (IJRAR.ORG)

🔥 International Peer Reviewed & Refereed Journal, Open Access Journal 🔥

📖 ISSN Approved Journal No: E-ISSN 2348-1269, P- ISSN 2349-5138 📖

🔥 Journal ESTD Year: 2014 🔥

🔥 Call For Paper - Volume 10 | Issue 2 | Month- May 2023

(<https://ijrar.org/submitonline.php>) 🔥

()

📖 Read all new guidelines related publication before submission or publication. Scholarly open access , Peer-reviewed, and Refereed, Impact Factor: 7.17, AI-Powered Research Tool , Multidisciplinary, Monthly, Indexing in all major database & Metadata, Citation Generator, Digital Object Identifier(DOI), UGC Approved Journal No: 43602(19) ()

➡ Submit Paper

(<https://ijrar.org/submitonline.php>)

➡ Contact Us
Click Here
Login to Author Home
Contact
Click Here

(<http://www.ijrar.org/Authorhome/alogin.php>)

📊 IJRAR.COM Repository

(<https://ijrar.org/archivelist.php>)

🗨️ Communication Guidelines

(<https://ijrar.org/Communication%20Guidelines.pdf>)

(Communication Guidelines.pdf)

([https://wa.me/916354477117/?text=Hi IJRAR](https://wa.me/916354477117/?text=Hi%20IJRAR))

 **IJRAR Search Xplore - Search all paper by Paper Name , Author Name, and Title**

Search by Paper id, Published paper id, Paper Name , Author Name, ε [Click here to search Q](#)

 **Review Process Policy**

([reviewprocess.php](#))

 **Open access Publishing Policy**

([openaccess.php](#))

 **Publication Ethics Policy**

([ethics.php](#))

 **Track Status of Paper / Login to Author Home**

(<http://www.ijrar.org/Authorhome/alogin.php>)

 **Call For Paper - Current Issue May 2023**

[Contact Us](#)
[Click Here](#)
[Contact](#)
[Click Here](#)

([callforpaper.php](#))

 **Submit Paper Online Submit Word file of Paper**

([submitonline.php](#))

 **Online Payment Link**





(http://ijrar.org/pay_form_2.php)

	Publication Guidelines
---	-------------------------------

([pubGuide.php](http://ijrar.org/pubGuide.php))

	Join Reviewer / RMS Earn 300 INR
---	---

(<http://www.ijrar.org/JoinAsReviewer.php>)

 Check Paper Status	(https://www.ijrar.org/Authorhome/alogin.php)
 Submit Paper Online	(https://ijrar.org/submitonline.php)
	 Call For Paper Details

(<https://ijrar.org/callforpaper.php>)

QUICK LINKS

(<http://ijrar.org/submitonline.php>)



(<http://ijrar.org/submitonline.php>)
**SUBMIT YOUR PAPER
ONLINE (HTTP://IJRAR.ORG/SUBMITONLINE.PHP)**

(http://ijrar.org/pay_form_2.php)



(http://ijrar.org/pay_form_2.php)
**PAY FEES
ONLINE (HTTP://IJRAR.ORG/PAY_FORM_2.PHP)**

(<http://ijrar.org/pubGuide.php>)



(<http://ijrar.org/pubGuide.php>)
**AUTHOR
INSTRUCTIONS AND
PUBLICATION GUIDELINES (HTTP://IJRAR.ORG/PUBGUIDE.PHP)**

(<http://ijrar.org/callforpaper.php>)



(<http://ijrar.org/callforpaper.php>)
**CALL FOR PAPER
PUBLICATION FEES DETAILS &
SCHEDULE OF PUBLICATION (HTTP://IJRAR.ORG/CALLFORPAPER.PHP)**

([Peer Review Policy.php](http://ijrar.org/PeerReviewPolicy.php))

Contact Us
[Click Here](#)
[Contact](#)
[Click Here](#)





(<http://ijrar.org/Ethics.php>)

(Peer Review Policy.php)

PEER REVIEW POLICY

OR PEER REVIEW STATEMENT (PEER REVIEW POLICY.PHP)



(openaccess.php)

(<http://ijrar.org/Ethics.php>)

COPE ETHICS AND

MALPRACTICE STATEMENT (HTTP://IJRAR.ORG/ETHICS.PHP)



(<http://ijrar.org/callforpaper.php>)

(openaccess.php)

OPEN ACCESS POLICY (OPENACCESS.PHP)



([all policy.php](http://allpolicy.php))

(<http://ijrar.org/callforpaper.php>)

AIMS AND SCOPE (HTTP://IJRAR.ORG/CALLFORPAPER.PHP)



([all policy.php](http://allpolicy.php))

ALL POLICY (ALL POLICY.PHP)

(<http://ijrar.org/faq.php>)



(<http://ijrar.org/contact.php>)

(<http://ijrar.org/faq.php>)

FAQ PAGE (HTTP://IJRAR.ORG/FAQ.PHP)



(<http://ijrar.org/contact.php>)

CONTACT US (HTTP://IJRAR.ORG/CONTACT.PHP)

PUBLICATION PROCESS

Follow this step and publish your research paper



SUBMIT ARTICLE

(<http://ijrar.org/submitonline.php>)



PEER REVIEW PROCESS

(Peer Review Policy.php)



Contact Us
Click Here
Contact
Click Here





PAPER PUBLISH ONLINE
(<http://ijrar.org/archivelist.php>)

About IJRAR (Refereed Journal, Peer Journal and Indexed Journal)

International Journal of Research and Analytical Reviews (IJRAR) is a Leading high quality open access & peer reviewed quarterly published research journal. IJRAR is providing a platform for the researchers, academicians, professional, practitioners and students to impart and share knowledge in the form of high quality empirical and theoretical research papers, case studies, literature reviews and book reviews. The aim of the journal is to provide platform for diversity of intellectual pursuit from all corners of the society for enrichment and enhancement of the group readers. The Journal welcomes and acknowledges high quality theoretical and empirical original research papers, case studies, review papers, literature reviews, book reviews, conceptual framework, analytical and simulation models, technical note from researchers, academicians, professional, practitioners and students from all over the world.

The journal is being published Quarterly and in the multi-lingual likewise English, Hindi, Gujarati, & Sanskrit.

IJRAR is Scholarly open access journals, Peer-reviewed, and Refereed Journal, AI-Powered Research Tool, Multidisciplinary, Quarterly, Indexing in all major database & Metadata, Citation Generator, Digital Object Identifier(DOI) with Open-Access Publications..



Current Issue :

Current Issue : Volume 10 | Issue 2 | Month- May 2023

International Peer-reviewed, Refereed Journals, and Open Access Journal | Scholarly Open access journals, Multidisciplinary, Monthly, Indexing in all major database.



Paper Submission Till :

Paper Submission Till : 31-May-2023

You can Submit your paper any time no deadline for paper submission.



Review Results (Acceptance/Rejection) Notification :

Review Results (Acceptance/Rejection) Notification: Within as per Peer-Review guidelines.



Paper Publication Time :

Paper Publish: Within Within as per Peer-Review guidelines.

Contact Us
Click Here
Contact
Click Here



⚙️ Important Journal Details

📌 **INTERNATIONAL JOURNAL OF RESEARCH AND ANALYTICAL REVIEWS (IJRAR.ORG) | ISSN Approved Journal No: E-ISSN 2348-1269, P- ISSN 2349-5138 Journal ESTD Year: 2014**

📌 **Journal Type:** International Peer Reviewed, Open Access Journal, Scholarly open access journals, Peer-reviewed, and Refereed Journals, AI-Powered Research Tool , Multidisciplinary, Monthly, Indexing in all major database & Metadata, Citation Generator, Digital Object Identifier(DOI)

📌 **Issue Frequency:** Quarterly (4 issue Annually)

📌 **Publication Guidelines:** Follow COPE Guidelines

📌 **Refereed Journal, Peer Journal and Indexed Journal**

📌 **Journal Discipline and Subject :** Multidisciplinary, Monthly, Multilanguage (Regional language supported) .

📌 **Publisher and Managed By :** IJPUBLICATION (ijpublication.org).

📌 **Publication Supported Languages:** Allow All Multiple Languages (Regional language supported).

📌 **ISSN:** E-ISSN 2348-1269, P- ISSN 2349-5138 | ISSN Approved . ()

📌 **Current Issue Details (callforpaper.php):** Call For Paper (Volume 10 | Issue 2 | Month- May 2023) (callforpaper.php)

📌 **Subject Category : Multidisciplinary, Monthly scholarly open access journals (ResearchArea.php)**

📌 **DOI and HARD copy of certificate Provide.**

📌 **Peer-reviewed, Refereed Journals.**

[call for paper \(callforpaper.php\)](https://www.ijrar.org/callforpaper.php)

[All Policy \(https://ijrar.org/all%20policy.php\)](https://www.ijrar.org/all%20policy.php)

[Submit Paper Online \(https://ijrar.org/submitonline.php\)](https://www.ijrar.org/submitonline.php)

⚙️ Important Dates regarding Publication Procedure



Current Issue :

Current Issue : Volume 10 | Issue 2 | Month- May 2023

International Peer-reviewed, Refereed Journals, and Open Access Journal | Scholarly Open access journals, Multidisciplinary, Monthly, Indexing in all major database.

[Contact Us](#)
[Click Here](#)
[Contact](#)
[Click Here](#)



Paper Submission Till :

Paper Submission Till : 31-May-2023

You can Submit your paper any time no deadline for paper submission.



Review Results (Acceptance/Rejection) Notification :

Review Results (Acceptance/Rejection) Notification: Within as per Peer-Review guidelines.





Paper Publication Time :

Paper Publish: Within Within as per Peer-Review guidelines.

Types of Articles invited

Research Papers, Survey Papers, Study Papers, Subjective Papers, Experimental Result Papers, Analysis Study Research Papers, Informative Article, Comparison Papers, Case Studies Papers, Review Papers, Comparative Studies, Dissertation Chapters, Research Proposals or Synopsis, Working Projects, New Innovation & Idea, Prototypes and Models and many More

[Check Paper Status](#)

<https://www.ijrar.org/Authorhome/alogin.php>

[Contact Us](#)

<https://ijrar.org/contact.php>

[Submit Paper Online](#)

<https://ijrar.org/submitonline.php>

[Call For Paper Details](#)

<https://ijrar.org/callforpaper.php>

IJRAR is Peer Review and Refereed Journal

Monthly, Multidisciplinary and Multilanguage (Regional language supported)

Publish Paper within 1 to 2 days.

DOI, Certificate and Hard Copy of Journal Provided.

Indexed in all major open databases

Fast, Transparent & Easy Publication process

Automated Metadata and Citation Generator of all paper

2000+ Prestigious Reviewers from Well-known Institutes/Universities among the world

IJRAR Journal Details:

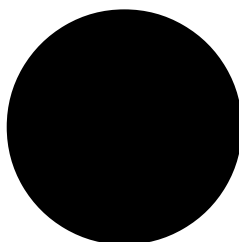

[Contact Us](#)
[Click Here](#)
[Contact](#)
[Click Here](#)

Call For Paper (Volume 10 | Issue 2 | Month- May 2023) (callforpaper.php)

Submit Paper to IJRAR.ORG Submit Paper online Only

IJRAR - International Journal of Research and Analytical Reviews (IJRAR)

Issue Frequency: Quarterly (4 issue Annually)

Publication Guidelines: Follow COPE Guidelines



- 🚩 **High impact factor and 50+ index database and Fast paper publication.**
- 🚩 **Nominal Fee for Professional Research Services, Low cost research journal.**
- 🚩 **Publication Guidelines : COPE Guidelines**
- 🚩 **Quick, Fast, automatic Speedy Review and publication Process**
- 🚩 **Notification of Review Result and publication - Within 02-03 Days.**
- 🚩 **Provide Free e-certificate to all author and DOI (Digital Object Identifiers) to All Paper.**
- 🚩 **Download all digital data from website anytime lifetime available.**
- 🚩 **Indexing of paper in all major online journal databases.**
- 🚩 **ISSN: E-ISSN 2348-1269, P- ISSN 2349-5138 | ISSN Approved . ()**
- 🚩 **Provide DOI and Hard copy of Certificate.**
- 🚩 **Low Open Access Processing Charges**
- 🚩 **Call For Paper (Volume 10 | Issue 2 | Month- May 2023) (callforpaper.php)**

[Online Paper Submission](#)

(submitonline.php) [Learn More for call for paper \(callforpaper.php\)](#)

⚙️ Benefits of Publishing Paper in IJRAR

- **Refereed Journal, Peer Journal and Indexed Journal and Quick, qualitative and Speedy Review and Publication Process**
- **Check Your Paper Status online using Paper registration id and Author Email Address (http://www.ijrar.org/Authorhome/alogin.php)**
- **IJRAR Started “ Go Green Initiative “ by providing the e-Confirmation letter, e-certificate to each author for the publication of the paper.(We are providing the Hard Copy of certificate and confirmation letter on Request based only(for indian author) with additional charges.)**
- **Soft Copy of "Certificate of Publication" of all authors (instantly available after publication)**
- **Automated Metadata and Indexing Citation Generator**
- **Provide A Free digital object identifier (DOI) Like our Facebook Page and free DOI. (doi.php)**
- **Provide the Mail and SMS notification to the author for each stage of the paper**

[Contact Us](#)
[Click Here](#)
[Contact](#)
[Click Here](#)



publication procedure.



IJRAR has Highly Secure SSL Certificate Based website (<http://www.ijrar.org>)

(<http://www.ijrar.org>)



Prestigious Reviewers from Well-known Institutes/Universities among the world.



Provided Hard Copy of Certificate on Request based only additional charges.



Meta Level Programming in order to make your paper SEO effective and Automated Citation Generator



provide author research guidelines & support by mail, SMS and the call.



Indexing of paper in all major online journal databases like Google Scholar, ResearcherID Thomson Reuters Indexing, Mendeley : reference manager, Academia.edu, arXiv.org : cornell university library, Thomson Reuters, Research Gate, CiteSeerX, DOAJ : Directory of Open Access Journals, DRJI, DocStoc, GetCited,Base,ISEDN, Wiki CFP, Index Copernicus International, Cabell's Directory, Open J Gate, ISSUU, Scribd, ASI : Advance Science Indexing, RefSeek, Utem.

Contact Us

Authors can communicate any time to IJRAR through mail - editor@ijrar.org (<mailto:editor@ijrar.org>) If author have paper registration ID then kindly mention it in the subject field of the mail.

Editor In Cheif :
Dr. Samuel M. Muriithi
Director, Academic Programs, Daystar University
Verified email at daystar.ac.ke

Editor Google Scholar Profile

(<https://scholar.google.co.za/citations?user=...>)

Address:
IJRAR
210 Ganesh Glory Near godrej garden city Jagatpur, Ahmedabad, Gujarat.

Contact Us
[Click Here](#)
Contact
[Click Here](#)

[Communication Guidelines/Process \(Communication Guidelines.pdf\) \(Phone\)](#)



✉ E.(Email): editor@ijrar.org (mailto:editor@ijrar.org)

🕒 H (Working Days/Hours) (Hours): Monday - Friday: 11:00 AM to 07:00 PM IST

Communication Guidelines/Process:

📣 **Every Day we received very large number of call so it's decrease our work efficiency so we deiced to provide support on WhatsApp and Email only.**

📣 **NOTE: We give Priority to email only so first send your any query to email only. we will solve your query within 2 to 4 day.**

📣 Option 1: First Priority

Send your query through Email only.
Our team will respond you within 2 to 4 days.

Email id: editor@ijrar.org
(mailto:editor@ijrar.org)
Note: Send all query to this email address editor@ijrar.org
(mailto:editor@ijrar.org)

📣 Option 2: WhatsApp

Save Our Contact No in your mobile phone with name "IJRAR Journal"

📞 WhatsApp Contact: +91 63 54 47 71 17 (<https://wa.me/916354477117>)
<https://wa.me/916354477117>
(<https://wa.me/916354477117>)
Note: Do not call on this number Only send your query to WhatsApp only

📣 Option 3: "Call Request"

if using above 1&2 Option your query doesn't resolve then follow below procedure to contact Editor Send me "Call Request " to WhatsApp and Email With your mobile no and query. Our editor sir will contact you soon.

Send me "Call Request" to WhatsApp and email with your mobile no and query. so our editor sir will contact you.

Email id: editor@ijrar.org
(mailto:editor@ijrar.org)
WhatsApp Contact : +91 63 54 47 71 17
(<https://wa.me/916354477117>)

NOTE: You can use any of above three options and we will solve your all problem within 2 to 3 day. Thank you for your kind support.

Contact Us
Click Here
Contact
Click Here



Call For Paper May 2023



Call For Papers

May 2023 (callforpaper.php)

Volume 10 | Issue 2



Last Date :**31-May-2023****📄 Review Results : Within 02-03 Days****📄 Paper Publication : Within 02-03 Days (callforpaper.php)****📄 Submit Manuscript Online (submitonline.php)****⚙️ Published Issue Details****🌿 Current Issue (<http://www.ijrar.org/archive.php?vol=10&issue=2>)****🌿 Past Issue ([archivelist.php](#))****🌿 Conference Proceedings ([ConferenceProposal.php](#))****🌿 Sample Certificate (http://www.ijrar.org/Content/Images/new_ijcrt/sample_CERTIFICATE.png)****🌿 Sample Publication letter (http://www.ijrar.org/Content/Images/new_ijcrt/sampleletter.png)****🌿 Sample Hardcopy of Journal (<https://ijrar.org/hardcopysampleflip.php>)****🌿 Sample Paper format ([Content/Files/IJRAR_PaperFormat.docx](#))****🌿 CopyRight Transfer Form ([Content/Files/IJRAR_CopyrightTransferForm.pdf](#))****🌿 Undertaking Form ([Content/Files/IJRAR_UndertakingByAuthors.pdf](#))****⚙️ For Authors****🌿 Call For Paper ([callforpaper.php](#))****🌿 Track Submitted Paper (<http://www.ijrar.org/Authorhome/alogin.php>)****🌿 Submit Manuscript online ([submitonline.php](#))****🌿 Publication Guidelines ([pubGuide.php](#))****Contact Us****📄 [Click Here](#)****📄 [Contact](#)**
📄 [Click Here](#)

 [Pay Online \(http://ijrar.org/pay_form_2.php\)](http://ijrar.org/pay_form_2.php)

 [Hardcopy Related \(paymentInfo.php\)](#)

 [DOI \(doi.php\)](#)

 [List of Research Area \(ResearchArea.php\)](#)

 [Impact Factor \(impactfactor.php\)](#)

 **Forms / Downloads**

 [Sample Paper format \(Content/Files/IJRAR_PaperFormat.docx\)](#)

 [CopyRight Transfer Form \(Content/Files/IJRAR_CopyrightTransferForm.pdf\)](#)

 [Undertaking Form \(Content/Files/IJRAR_UndertakingByAuthors.pdf\)](#)

 **Research Area**

 [Engineering \(http://www.ijrar.org/ResearchArea.php\)](http://www.ijrar.org/ResearchArea.php)

 [Science & Technology \(http://www.ijrar.org/ResearchArea.php\)](http://www.ijrar.org/ResearchArea.php)

 [Pharmacy \(http://www.ijrar.org/ResearchArea.php\)](http://www.ijrar.org/ResearchArea.php)

 [Science All \(http://www.ijrar.org/ResearchArea.php\)](http://www.ijrar.org/ResearchArea.php)

 [Commerce \(http://www.ijrar.org/ResearchArea.php\)](http://www.ijrar.org/ResearchArea.php)

 [Arts \(http://www.ijrar.org/ResearchArea.php\)](http://www.ijrar.org/ResearchArea.php)

 [Medical Science \(http://www.ijrar.org/ResearchArea.php\)](http://www.ijrar.org/ResearchArea.php)

[Contact Us](#)
[Click Here](#)
[Contact](#)
[Click Here](#)



 **Life Sciences** (<http://www.ijrar.org/ResearchArea.php>)

 **Health Science** (<http://www.ijrar.org/ResearchArea.php>)

 **Social Science and Humanities** (<http://www.ijrar.org/ResearchArea.php>)

 **Managment and Tourism** (<http://www.ijrar.org/ResearchArea.php>)

 **LAW & Education** (<http://www.ijrar.org/ResearchArea.php>)

 **Other IMP Links**

 **START A NEW JOURNAL & JOURNAL SUPPORTING SOFTWARE**
(<https://ijrar.org/How%20to%20start%20new%20journal%20&%20journal%20supporting%20software.php>)

 **Publish BOOK, DISSERTATION AND THESIS** (<https://ijrar.org/bookpub.php>)

 **Best Research Paper Award** (<bestpaperaward.php>)

 **Conference/ Special Issue Praposal** (<https://ijrar.org/ConferenceProposal.php>)

 **LICENSE**

 **This work is licensed under a Creative Commons Attribution-NonCommercial 4.0 International License** (<http://creativecommons.org/licenses/by-nc/3.0/>)



(<http://creativecommons.org/licenses/by-nc/3.0/>)

Contact Us
Click Here
Contact
Click Here

 **Open Access**





UGC Approved



 [IJRAR.ORG](https://www.ijrar.org)

IJRAR is Peer Review

Refereed

Open access

Monthly,
Multidisciplinary,
Multilanguage

Online, Print Journal

ISSN Approved



INTERNATIONAL
STANDARD
SERIAL
NUMBER

Contact Us
[Click Here](#)
Contact
[Click Here](#)



 E-ISSN 2348-1269,

P- ISSN 2349-5138

 UGC ISSN APPROVED

 Journal Starting Year (ESTD) : 2014



E-ISSN 2348-1269, P- ISSN 2349-5138



 IJRAR.ORG

IJRAR is Peer Review

Refereed

Open access

Monthly,
Multidisciplinary,
Multilanguage

Online, Print Journal

ISSN Approved



INTERNATIONAL
STANDARD
SERIAL
NUMBER

Contact Us
[Click Here](#)
[Contact](#)
[Click Here](#)

 E-ISSN 2348-1269,

P- ISSN 2349-5138



 **UGC ISSN APPROVED**

 **Journal Starting Year (ESTD) : 2014**



E-ISSN 2348-1269, P- ISSN 2349-5138



 **DOI Details**



(doi.php)

 Providing A Free digital object identifier by DOI.one (doi.php) How to get DOI? (doi.php)

[Contact Us](#)
[Click Here](#)
[Contact](#)
[Click Here](#)

 **CONFERENCE**



🔗 CONFERENCE MANAGMENT & PUBLICATION CONFERENCE PROPOSAL (ConferenceProposal.php)

🔗 RECENT CONFERENCE (ConferenceProposal.php)

RECENT NEW CONFERENCE CONFERENCE PROPOSAL & CONFERENCE PROCEEDINGS

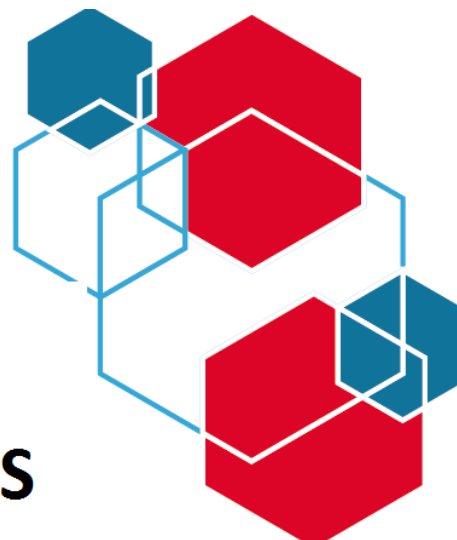

(ConferenceProposal.php)

🔗 CONFERENCE PROPOSAL (ConferenceProposal.php)

🔗 CONFERENCE PROCEEDINGS (ConferenceProposal.php)

⚙️ For Reviewer /Referral (RMS) Earn 300 per paper

🌿 About RMS (aboutRMS.php)

🌿 Editorial Board (editorialBoard.php)

🌿 Login into RMS Account (http://www.ijrar.org/rms/login.php)

🌿 Join reviewer/RMS Member (JoinAsReviewer.php)

Contact Us
Click Here
Click Here
Contact
Click Here

⚙️ Important Links

🌿 Major Indexing (callforpaper.php)



 [All Policy \(https://ijrar.org/all%20policy.php\)](https://ijrar.org/all%20policy.php)

 [Payment Terms/Refund Policy \(https://ijrar.org/all%20policy.php\)](https://ijrar.org/all%20policy.php)

 [FAQ \(faq.php\)](faq.php)

 [Privacy Policy \(https://ijrar.org/all%20policy.php\)](https://ijrar.org/all%20policy.php)

 [Copyright infringement claims \(https://ijrar.org/all%20policy.php\)](https://ijrar.org/all%20policy.php)





 Digital Library



Search Your Paper Details.

[\(search.php\)](search.php)

 Open Access

	OPEN KNOWLEDGE	(http://opendefinition.org/)
	OPEN DATA	(http://opendefinition.org/)
	OPEN CONTENT	(http://opendefinition.org/)
	OPEN SERVICE	(http://opendefinition.org/ossed/)

 LICENSE

Contact Us
[Click Here](#)
[WhatsApp](#)
[Contact](#)
[Click Here](#)

 This work is licensed under a Creative Commons Attribution-NonCommercial 4.0 International License
[\(http://creativecommons.org/licenses/by-nc/3.0/\)](http://creativecommons.org/licenses/by-nc/3.0/)



[\(http://creativecommons.org/licenses/by-nc/3.0/\)](http://creativecommons.org/licenses/by-nc/3.0/)



Open Access





UGC Approved



🏠 IJRAR

🚩 International Peer Reviewed, Open Access Journal |International Peer Reviewed, Open Access Journal, Scholarly open access journals, Peer-reviewed, and Refereed Journals, AI-Powered Research Tool , Multidisciplinary, Monthly, Indexing in all major database & Metadata, Citation Generator, Digital Object Identifier(DOI).

Important Links

- Call for Paper ([callforpaper.php](http://www.ijrar.org/callforpaper.php))
- Submit Paper online ([submitonline.php](http://www.ijrar.org/submitonline.php))
- Publication Process ([pubGuide.php](http://www.ijrar.org/pubGuide.php))
- Current Issue (<http://www.ijrar.org/archive.php?vol=10&issue=2>)
- Contact Us ([contact.php](http://www.ijrar.org/contact.php))

Contact Us
 Click Here
 Contact
 Click Here

© Copyright 2023 [ijrar.org](http://www.ijrar.org) ([index.php](http://www.ijrar.org/index.php)) All rights reserved

🏠 Home ([index.php](http://www.ijrar.org/index.php)) | Terms & Conditions (<https://ijrar.org/all%20policy.php>) | All Policy (<https://ijrar.org/all%20policy.php>) | Contact us (<http://www.ijrar.org/contact.php>)

How start New Journal & software (<http://ijrar.org/How to start new journal & journal supporting software.php>)

Book & Thesis Publications (<http://ijrar.org/bookpub.php>) IJRAR is Peer Review Refereed Open access

Monthly, Multidisciplinary, Multilanguage Online, Print Journal



(<https://www.ijrar.org>)

INTERNATIONAL JOURNAL OF RESEARCH AND ANALYTICAL REVIEWS (IJRAR.ORG)

International Peer Reviewed & Refereed Journal, Open Access Journal

ISSN Approved Journal No: E-ISSN 2348-1269, P- ISSN 2349-5138

Journal ESTD Year: 2014

Call For Paper - Volume 10 | Issue 2 | Month- May 2023

(<https://ijrar.org/submitonline.php>)

()

Read all new guidelines related publication before submission or publication. Scholarly open access , Peer-reviewed, and Refereed, Impact Factor: 7.17, AI-Powered Research Tool , Multidisciplinary, Monthly, Indexing in all major database & Metadata, Citation Generator, Digital Object Identifier(DOI), UGC Approved Journal No: 43602(19) ()

[Submit Paper](#)

(<https://ijrar.org/submitonline.php>)

[Contact Us](#)
[Click Here](#)
[Login to Author Home](#)
[Contact](#)
[Click Here](#)

(<http://www.ijrar.org/Authorhome/alogin.php>)

[IJRAR.COM Repository](#)

(<https://ijrar.org/archivelist.php>)

[Communication Guidelines](#)

(<https://ijrar.org/Communication%20Guidelines.pdf>)

(Communication Guidelines.pdf)

([https://wa.me/916354477117/?text=Hi IJRAR](https://wa.me/916354477117/?text=Hi%20IJRAR))

 **IJRAR Search Xplore - Search all paper by Paper Name , Author Name, and Title**

Search by Paper id, Published paper id, Paper Name , Author Name, ε [Click here to search Q](#)

 **Review Process Policy**

([reviewprocess.php](#))

 **Open access Publishing Policy**

([openaccess.php](#))

 **Publication Ethics Policy**

([ethics.php](#))

 **Track Status of Paper / Login to Author Home**

(<http://www.ijrar.org/Authorhome/alogin.php>)

 **Call For Paper - Current Issue May 2023**

([callforpaper.php](#))

 **Submit Paper Online Submit Word file of Paper**

([submitonline.php](#))

 **Online Payment Link**



Contact Us
Click Here
Contact
Click Here



(http://ijrar.org/pay_form_2.php)

	Publication Guidelines
---	-------------------------------

([pubGuide.php](http://ijrar.org/pubGuide.php))

	Join Reviewer / RMS Earn 300 INR
---	---

(<http://www.ijrar.org/JoinAsReviewer.php>)

 Check Paper Status (https://www.ijrar.org/Authorhome/alogin.php)	
 Submit Paper Online (https://ijrar.org/submitonline.php)	 Call For Paper Details (https://ijrar.org/callforpaper.php)

QUICK LINKS

(<http://ijrar.org/submitonline.php>)



(<http://ijrar.org/submitonline.php>)
**SUBMIT YOUR PAPER
ONLINE (HTTP://IJRAR.ORG/SUBMITONLINE.PHP)**

(http://ijrar.org/pay_form_2.php)



(http://ijrar.org/pay_form_2.php)
**PAY FEES
ONLINE (HTTP://IJRAR.ORG/PAY_FORM_2.PHP)**

(<http://ijrar.org/pubGuide.php>)



(<http://ijrar.org/pubGuide.php>)
**AUTHOR
INSTRUCTIONS AND
PUBLICATION GUIDELINES (HTTP://IJRAR.ORG/PUBGUIDE.PHP)**

(<http://ijrar.org/callforpaper.php>)



(<http://ijrar.org/callforpaper.php>)
**CALL FOR PAPER
PUBLICATION FEES DETAILS &
SCHEDULE OF PUBLICATION (HTTP://IJRAR.ORG/CALLFORPAPER.PHP)**

([Peer Review Policy.php](http://ijrar.org/PeerReviewPolicy.php))

Contact Us
[Click Here](#)
[Contact](#)
[Click Here](#)





(<http://ijrar.org/Ethics.php>)

(Peer Review Policy.php)

PEER REVIEW POLICY

OR PEER REVIEW STATEMENT (PEER REVIEW POLICY.PHP)



(openaccess.php)

(<http://ijrar.org/Ethics.php>)

COPE ETHICS AND

MALPRACTICE STATEMENT (HTTP://IJRAR.ORG/ETHICS.PHP)



(<http://ijrar.org/callforpaper.php>)

(openaccess.php)

OPEN ACCESS POLICY (OPENACCESS.PHP)



([all policy.php](http://allpolicy.php))

(<http://ijrar.org/callforpaper.php>)

AIMS AND SCOPE (HTTP://IJRAR.ORG/CALLFORPAPER.PHP)



([all policy.php](http://allpolicy.php))

ALL POLICY (ALL POLICY.PHP)

(<http://ijrar.org/faq.php>)



(<http://ijrar.org/contact.php>)

(<http://ijrar.org/faq.php>)

FAQ PAGE (HTTP://IJRAR.ORG/FAQ.PHP)



(<http://ijrar.org/contact.php>)

CONTACT US (HTTP://IJRAR.ORG/CONTACT.PHP)

PUBLICATION PROCESS

Follow this step and publish your research paper



SUBMIT ARTICLE

(<http://ijrar.org/submitonline.php>)



PEER REVIEW PROCESS

(Peer Review Policy.php)



Contact Us
Click Here
Contact
Click Here





PAPER PUBLISH ONLINE
(<http://ijrar.org/archivelist.php>)

About IJRAR (Refereed Journal, Peer Journal and Indexed Journal)

International Journal of Research and Analytical Reviews (IJRAR) is a Leading high quality open access & peer reviewed quarterly published research journal. IJRAR is providing a platform for the researchers, academicians, professional, practitioners and students to impart and share knowledge in the form of high quality empirical and theoretical research papers, case studies, literature reviews and book reviews. The aim of the journal is to provide platform for diversity of intellectual pursuit from all corners of the society for enrichment and enhancement of the group readers. The Journal welcomes and acknowledges high quality theoretical and empirical original research papers, case studies, review papers, literature reviews, book reviews, conceptual framework, analytical and simulation models, technical note from researchers, academicians, professional, practitioners and students from all over the world.

The journal is being published Quarterly and in the multi-lingual likewise English, Hindi, Gujarati, & Sanskrit.

IJRAR is Scholarly open access journals, Peer-reviewed, and Refereed Journal, AI-Powered Research Tool, Multidisciplinary, Quarterly, Indexing in all major database & Metadata, Citation Generator, Digital Object Identifier(DOI) with Open-Access Publications..



Current Issue :

Current Issue : Volume 10 | Issue 2 | Month- May 2023

International Peer-reviewed, Refereed Journals, and Open Access Journal | Scholarly Open access journals, Multidisciplinary, Monthly, Indexing in all major database.



Paper Submission Till :

Paper Submission Till : 31-May-2023

You can Submit your paper any time no deadline for paper submission.



Review Results (Acceptance/Rejection) Notification :

Review Results (Acceptance/Rejection) Notification: Within as per Peer-Review guidelines.



Paper Publication Time :

Paper Publish: Within Within as per Peer-Review guidelines.

Contact Us
Click Here
Contact
Click Here



⚙️ Important Journal Details

📌 **INTERNATIONAL JOURNAL OF RESEARCH AND ANALYTICAL REVIEWS (IJRAR.ORG) | ISSN Approved Journal No: E-ISSN 2348-1269, P- ISSN 2349-5138 Journal ESTD Year: 2014**

📌 **Journal Type:** International Peer Reviewed, Open Access Journal, Scholarly open access journals, Peer-reviewed, and Refereed Journals, AI-Powered Research Tool , Multidisciplinary, Monthly, Indexing in all major database & Metadata, Citation Generator, Digital Object Identifier(DOI)

📌 **Issue Frequency:** Quarterly (4 issue Annually)

📌 **Publication Guidelines:** Follow COPE Guidelines

📌 **Refereed Journal, Peer Journal and Indexed Journal**

📌 **Journal Discipline and Subject :** Multidisciplinary, Monthly, Multilanguage (Regional language supported) .

📌 **Publisher and Managed By :** IJPUBLICATION (ijpublication.org).

📌 **Publication Supported Languages:** Allow All Multiple Languages (Regional language supported).

📌 **ISSN:** E-ISSN 2348-1269, P- ISSN 2349-5138 | ISSN Approved . ()

📌 **Current Issue Details (callforpaper.php):** Call For Paper (Volume 10 | Issue 2 | Month- May 2023) (callforpaper.php)

📌 **Subject Category : Multidisciplinary, Monthly scholarly open access journals (ResearchArea.php)**

📌 **DOI and HARD copy of certificate Provide.**

📌 **Peer-reviewed, Refereed Journals.**

[call for paper \(callforpaper.php\)](https://www.ijrar.org/callforpaper.php)

[All Policy \(https://ijrar.org/all%20policy.php\)](https://www.ijrar.org/all%20policy.php)

[Submit Paper Online \(https://ijrar.org/submitonline.php\)](https://www.ijrar.org/submitonline.php)

⚙️ Important Dates regarding Publication Procedure



Current Issue :

Current Issue : Volume 10 | Issue 2 | Month- May 2023

International Peer-reviewed, Refereed Journals, and Open Access Journal | Scholarly Open access journals, Multidisciplinary, Monthly, Indexing in all major database.

[Contact Us](#)
[Click Here](#)
[Contact](#)
[Click Here](#)

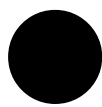

Paper Submission Till :

Paper Submission Till : 31-May-2023

You can Submit your paper any time no deadline for paper submission.



Review Results (Acceptance/Rejection) Notification :

Review Results (Acceptance/Rejection) Notification: Within as per Peer-Review guidelines.





Paper Publication Time :

Paper Publish: Within Within as per Peer-Review guidelines.

Types of Articles invited

Research Papers, Survey Papers, Study Papers, Subjective Papers, Experimental Result Papers, Analysis Study Research Papers, Informative Article, Comparison Papers, Case Studies Papers, Review Papers, Comparative Studies, Dissertation Chapters, Research Proposals or Synopsis, Working Projects, New Innovation & Idea, Prototypes and Models and many More

[Check Paper Status](#)

<https://www.ijrar.org/Authorhome/alogin.php>

[Contact Us](#)

<https://ijrar.org/contact.php>

[Submit Paper Online](#)

<https://ijrar.org/submitonline.php>

[Call For Paper Details](#)

<https://ijrar.org/callforpaper.php>

IJRAR is Peer Review and Refereed Journal

Monthly, Multidisciplinary and Multilanguage (Regional language supported)

Publish Paper within 1 to 2 days.

DOI, Certificate and Hard Copy of Journal Provided.

Indexed in all major open databases

Fast, Transparent & Easy Publication process

Automated Metadata and Citation Generator of all paper

2000+ Prestigious Reviewers from Well-known Institutes/Universities among the world

IJRAR Journal Details:

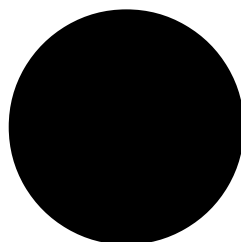

[Contact Us](#)
[Click Here](#)
[Contact](#)
[Click Here](#)

Call For Paper (Volume 10 | Issue 2 | Month- May 2023) (callforpaper.php)

Submit Paper to IJRAR.ORG Submit Paper online Only

IJRAR - International Journal of Research and Analytical Reviews (IJRAR)

Issue Frequency: Quarterly (4 issue Annually)

Publication Guidelines: Follow COPE Guidelines



- 🚩 **High impact factor and 50+ index database and Fast paper publication.**
- 🚩 **Nominal Fee for Professional Research Services, Low cost research journal.**
- 🚩 **Publication Guidelines : COPE Guidelines**
- 🚩 **Quick, Fast, automatic Speedy Review and publication Process**
- 🚩 **Notification of Review Result and publication - Within 02-03 Days.**
- 🚩 **Provide Free e-certificate to all author and DOI (Digital Object Identifiers) to All Paper.**
- 🚩 **Download all digital data from website anytime lifetime available.**
- 🚩 **Indexing of paper in all major online journal databases.**
- 🚩 **ISSN: E-ISSN 2348-1269, P- ISSN 2349-5138 | ISSN Approved . ()**
- 🚩 **Provide DOI and Hard copy of Certificate.**
- 🚩 **Low Open Access Processing Charges**
- 🚩 **Call For Paper (Volume 10 | Issue 2 | Month- May 2023) (callforpaper.php)**

[Online Paper Submission](#)

(submitonline.php)

[Learn More for call for paper \(callforpaper.php\)](#)

⚙️ Benefits of Publishing Paper in IJRAR

● Refereed Journal, Peer Journal and Indexed Journal and Quick, qualitative and Speedy Review and Publication Process

● Check Your Paper Status online using Paper registration id and Author Email Address (<http://www.ijrar.org/Authorhome/alogin.php>)

● IJRAR Started “ Go Green Initiative “ by providing the e-Confirmation letter, e-certificate to each author for the publication of the paper.(We are providing the Hard Copy of certificate and confirmation letter on Request based only(for indian author) with additional charges.)

● **Soft Copy of "Certificate of Publication" of all authors (instantly available after publication)**

● Automated Metadata and Indexing Citation Generator

● **Provide A Free digital object identifier (DOI) Like our Facebook Page and free DOI. (doi.php)**

● Provide the Mail and SMS notification to the author for each stage of the paper

[Contact Us](#)
[Click Here](#)
[Contact](#)
[Click Here](#)





publication procedure.

 IJRAR has Highly Secure SSL Certificate Based website (<http://www.ijrar.org>)
(<http://www.ijrar.org>)

 Prestigious Reviewers from Well-known Institutes/Universities among the world.

 Provided Hard Copy of Certificate on Request based only additional charges.

 Meta Level Programming in order to make your paper SEO effective and Automated Citation Generator

 provide author research guidelines & support by mail, SMS and the call.

 Indexing of paper in all major online journal databases like Google Scholar, ResearcherID Thomson Reuters Indexing, Mendeley : reference manager, Academia.edu, arXiv.org : cornell university library, Thomson Reuters, Research Gate, CiteSeerX, DOAJ : Directory of Open Access Journals, DRJI, DocStoc, GetCited,Base,ISEDN, Wiki CFP, Index Copernicus International, Cabell's Directory, Open J Gate, ISSUU, Scribd, ASI : Advance Science Indexing, RefSeek, Utem.

Contact Us

Authors can communicate any time to IJRAR through mail - editor@ijrar.org (<mailto:editor@ijrar.org>) If author have paper registration ID then kindly mention it in the subject field of the mail.

Editor In Cheif :
Dr. Samuel M. Muriithi
Director, Academic Programs, Daystar University
Verified email at daystar.ac.ke

 [Editor Google Scholar Profile](https://scholar.google.co.za/citations?user=4444444444444444) (<https://scholar.google.co.za/citations?user=4444444444444444>)

Address:
IJRAR
210 Ganesh Glory Near godrej garden city Jagatpur, Ahmedabad, Gujarat.

Contact Us
[Click Here](#)
Contact
[Click Here](#)

 [Communication Guidelines/Process \(Communication Guidelines.pdf\) \(Phone\)](#)

✉ E.(Email): editor@ijrar.org (mailto:editor@ijrar.org)

🕒 H (Working Days/Hours) (Hours): Monday - Friday: 11:00 AM to 07:00 PM IST

Communication Guidelines/Process:

📣 **Every Day we received very large number of call so it's decrease our work efficiency so we deiced to provide support on WhatsApp and Email only.**

📣 **NOTE: We give Priority to email only so first send your any query to email only. we will solve your query within 2 to 4 day.**

📣 Option 1: First Priority

Send your query through Email only.
Our team will respond you within 2 to 4 days.

Email id: editor@ijrar.org
(mailto:editor@ijrar.org)
Note: Send all query to this email address editor@ijrar.org
(mailto:editor@ijrar.org)

📣 Option 2: WhatsApp

Save Our Contact No in your mobile phone with name "IJRAR Journal"

📞 WhatsApp Contact: +91 63 54 47 71 17 (<https://wa.me/916354477117>)
<https://wa.me/916354477117>
(<https://wa.me/916354477117>)
Note: Do not call on this number Only send your query to WhatsApp only

📣 Option 3: "Call Request"

if using above 1&2 Option your query doesn't resolve then follow below procedure to contact Editor Send me "Call Request " to WhatsApp and Email With your mobile no and query. Our editor sir will contact you soon.

Send me "Call Request" to WhatsApp and email with your mobile no and query. so our editor sir will contact you.

Email id: editor@ijrar.org
(mailto:editor@ijrar.org)
WhatsApp Contact : +91 63 54 47 71 17 (<https://wa.me/916354477117>)

NOTE: You can use any of above three options and we will solve your all problem within 2 to 3 day. Thank you for your kind support.

Contact Us
Click Here
Contact
Click Here

⚙ Call For Paper May 2023

🔗 **Call For Papers**
May 2023 (callforpaper.php)
Volume 10 | Issue 2



Last Date :

31-May-2023

📌 Review Results : Within 02-03 Days

📌 Paper Publication : Within 02-03 Days (callforpaper.php)

📌 Submit Manuscript Online (submitonline.php)

⚙️ Published Issue Details

🌿 Current Issue (<http://www.ijrar.org/archive.php?vol=10&issue=2>)

🌿 Past Issue ([archivelist.php](#))

🌿 Conference Proceedings ([ConferenceProposal.php](#))

🌿 Sample Certificate (http://www.ijrar.org/Content/Images/new_ijcrt/sample_CERTIFICATE.png)

🌿 Sample Publication letter (http://www.ijrar.org/Content/Images/new_ijcrt/sampleletter.png)

🌿 Sample Hardcopy of Journal (<https://ijrar.org/hardcopysampleflip.php>)

🌿 Sample Paper format ([Content/Files/IJRAR_PaperFormat.docx](#))

🌿 CopyRight Transfer Form ([Content/Files/IJRAR_CopyrightTransferForm.pdf](#))

🌿 Undertaking Form ([Content/Files/IJRAR_UndertakingByAuthors.pdf](#))

⚙️ For Authors

🌿 Call For Paper ([callforpaper.php](#))

🌿 Track Submitted Paper (<http://www.ijrar.org/Authorhome/alogin.php>)

🌿 Submit Manuscript online ([submitonline.php](#))

🌿 Publication Guidelines ([pubGuide.php](#))

Contact Us
📌 [Click Here](#)
📌 [Contact](#)
📌 [Click Here](#)



 [Pay Online \(http://ijrar.org/pay_form_2.php\)](http://ijrar.org/pay_form_2.php)

 [Hardcopy Related \(paymentInfo.php\)](#)

 [DOI \(doi.php\)](#)

 [List of Research Area \(ResearchArea.php\)](#)

 [Impact Factor \(impactfactor.php\)](#)

Forms / Downloads

 [Sample Paper format \(Content/Files/IJRAR_PaperFormat.docx\)](#)

 [CopyRight Transfer Form \(Content/Files/IJRAR_CopyrightTransferForm.pdf\)](#)

 [Undertaking Form \(Content/Files/IJRAR_UndertakingByAuthors.pdf\)](#)

Research Area

 [Engineering \(http://www.ijrar.org/ResearchArea.php\)](http://www.ijrar.org/ResearchArea.php)

 [Science & Technology \(http://www.ijrar.org/ResearchArea.php\)](http://www.ijrar.org/ResearchArea.php)

 [Pharmacy \(http://www.ijrar.org/ResearchArea.php\)](http://www.ijrar.org/ResearchArea.php)

 [Science All \(http://www.ijrar.org/ResearchArea.php\)](http://www.ijrar.org/ResearchArea.php)

 [Commerce \(http://www.ijrar.org/ResearchArea.php\)](http://www.ijrar.org/ResearchArea.php)

 [Arts \(http://www.ijrar.org/ResearchArea.php\)](http://www.ijrar.org/ResearchArea.php)

 [Medical Science \(http://www.ijrar.org/ResearchArea.php\)](http://www.ijrar.org/ResearchArea.php)

[Contact Us](#)
[Click Here](#)
[Click Here](#)
[Contact](#)
[Click Here](#)



 **Life Sciences** (<http://www.ijrar.org/ResearchArea.php>)

 **Health Science** (<http://www.ijrar.org/ResearchArea.php>)

 **Social Science and Humanities** (<http://www.ijrar.org/ResearchArea.php>)

 **Managment and Tourism** (<http://www.ijrar.org/ResearchArea.php>)

 **LAW & Education** (<http://www.ijrar.org/ResearchArea.php>)

 **Other IMP Links**

 **START A NEW JOURNAL & JOURNAL SUPPORTING SOFTWARE**
(<https://ijrar.org/How%20to%20start%20new%20journal%20&%20journal%20supporting%20software.php>)

 **Publish BOOK, DISSERTATION AND THESIS** (<https://ijrar.org/bookpub.php>)

 **Best Research Paper Award** (<bestpaperaward.php>)

 **Conference/ Special Issue Praposal** (<https://ijrar.org/ConferenceProposal.php>)

 **LICENSE**

 **This work is licensed under a Creative Commons Attribution-NonCommercial 4.0 International License** (<http://creativecommons.org/licenses/by-nc/3.0/>)



(<http://creativecommons.org/licenses/by-nc/3.0/>)

Contact Us
Click Here
Contact
Click Here

 **Open Access**





UGC Approved



IJRAR.ORG

IJRAR is Peer Review

Refereed

Open access

Monthly,
Multidisciplinary,
Multilanguage

Online, Print Journal

ISSN Approved



INTERNATIONAL
STANDARD
SERIAL
NUMBER

Contact Us
[Click Here](#)
Contact
[Click Here](#)



 E-ISSN 2348-1269,

P- ISSN 2349-5138

 UGC ISSN APPROVED

 Journal Starting Year (ESTD) : 2014



E-ISSN 2348-1269, P- ISSN 2349-5138



 IJRAR.ORG

IJRAR is Peer Review

Refereed

Open access

Monthly,
Multidisciplinary,
Multilanguage

Online, Print Journal

ISSN Approved



INTERNATIONAL
STANDARD
SERIAL
NUMBER

Contact Us
[Click Here](#)
[Contact](#)
[Click Here](#)

 E-ISSN 2348-1269,

P- ISSN 2349-5138



 **UGC ISSN APPROVED**

 **Journal Starting Year (ESTD) : 2014**



E-ISSN 2348-1269, P- ISSN 2349-5138



 **DOI Details**



(doi.php)

 [Providing A Free digital object identifier by DOI.one \(doi.php\) How to get DOI? \(doi.php\)](#)

[Contact Us](#)
[Click Here](#)
[Contact](#)
[Click Here](#)

 **CONFERENCE**



🔗 [CONFERENCE MANAGMENT & PUBLICATION CONFERENCE PROPOSAL \(ConferenceProposal.php\)](#)

🔗 [RECENT CONFERENCE \(ConferenceProposal.php\)](#)

RECENT NEW CONFERENCE CONFERENCE PROPOSAL & CONFERENCE PROCEEDINGS



(ConferenceProposal.php)

🔗 [CONFERENCE PROPOSAL \(ConferenceProposal.php\)](#)

🔗 [CONFERENCE PROCEEDINGS \(ConferenceProposal.php\)](#)

⚙️ For Reviewer /Referral (RMS) Earn 300 per paper

🌿 [About RMS \(aboutRMS.php\)](#)

🌿 [Editorial Board \(editorialBoard.php\)](#)

🌿 [Login into RMS Account \(http://www.ijrar.org/rms/login.php\)](http://www.ijrar.org/rms/login.php)

🌿 [Join reviewer/RMS Member \(JoinAsReviewer.php\)](#)

[Contact Us](#)
[Click Here](#)
[Contact](#)
[Click Here](#)

⚙️ Important Links

🌿 [Major Indexing \(callforpaper.php\)](#)



 [All Policy \(https://ijrar.org/all%20policy.php\)](https://ijrar.org/all%20policy.php)

 [Payment Terms/Refund Policy \(https://ijrar.org/all%20policy.php\)](https://ijrar.org/all%20policy.php)

 [FAQ \(faq.php\)](faq.php)

 [Privacy Policy \(https://ijrar.org/all%20policy.php\)](https://ijrar.org/all%20policy.php)

 [Copyright infringement claims \(https://ijrar.org/all%20policy.php\)](https://ijrar.org/all%20policy.php)



 Digital Library



Search Your Paper Details.

[\(search.php\)](search.php)

 Open Access

	OPEN KNOWLEDGE	(http://opendefinition.org/)
	OPEN DATA	(http://opendefinition.org/)
	OPEN CONTENT	(http://opendefinition.org/)
	OPEN SERVICE	(http://opendefinition.org/ossed/)

 LICENSE

Contact Us
[Click Here](#)
[WhatsApp](#)
[Contact](#)
[Click Here](#)

 This work is licensed under a Creative Commons Attribution-NonCommercial 4.0 International License
[\(http://creativecommons.org/licenses/by-nc/3.0/\)](http://creativecommons.org/licenses/by-nc/3.0/)



[\(http://creativecommons.org/licenses/by-nc/3.0/\)](http://creativecommons.org/licenses/by-nc/3.0/)



Open Access





UGC Approved



🏠 IJRAR

📌 International Peer Reviewed, Open Access Journal |International Peer Reviewed, Open Access Journal, Scholarly open access journals, Peer-reviewed, and Refereed Journals, AI-Powered Research Tool , Multidisciplinary, Monthly, Indexing in all major database & Metadata, Citation Generator, Digital Object Identifier(DOI).

Important Links

- Call for Paper ([callforpaper.php](http://www.ijrar.org/callforpaper.php))
- Submit Paper online ([submitonline.php](http://www.ijrar.org/submitonline.php))
- Publication Process ([pubGuide.php](http://www.ijrar.org/pubGuide.php))
- Current Issue (<http://www.ijrar.org/archive.php?vol=10&issue=2>)
- Contact Us ([contact.php](http://www.ijrar.org/contact.php))

Contact Us
Click Here
Contact
Click Here

© Copyright 2023 [ijrar.org](http://www.ijrar.org) ([index.php](http://www.ijrar.org/index.php)) All rights reserved

🏠 Home ([index.php](http://www.ijrar.org/index.php)) | Terms & Conditions (<https://ijrar.org/all%20policy.php>) | All Policy (<https://ijrar.org/all%20policy.php>) | Contact us (<http://www.ijrar.org/contact.php>)

ગુજરાત સંશોધન મંડળનું ત્રૈમાસિક



JOURNAL
OF THE
Gujarat Research Society
"DO RESEARCH FOR GOOD OF MANKIND"—Jawaharlal Nehru.
1941-57

Journal of The Gujarat Research Society

[Home](#) [Archives](#) [About the Journal](#) [Submissions](#) [Privacy Statement](#) [Contact](#)[Home](#) / [Search](#)

Search

Advanced filters

*Published After**By Author**Published Before*

No Results

[Make a Submission](#)

Downloads

[Paper Template](#)

[Copyright Form](#)

Information

[For Readers](#)

[For Authors](#)

[For Librarians](#)

© Copyright by Journal of the Gujarat Research Society All Rights Reserved

A Cascaded Multilevel Inverter Using THI Method for Electric Traction Drive

Dr.Y.Seetha Mahalakshmi

Assoc. Professor

*Aurora Scientific Technological and Research Academy
Hyderabad*

B.Divya Bharathi

Assistant Professor

*Kasturba Gandhi Degree and PG College for Women
Hyderabad*

Abstract: Pulse Width Modulation variable speed drives are increasingly applied in many new industrial applications that require superior performance. Recently, developments in power electronics and semiconductor technology have led to improvements in power electronic systems. This proposed technique provides more flexibility to designers and can generate more voltage levels without losing any level which worsens THD characteristics. The possibility of extension or series connection of this basic in two topologies has been studied. As we increase the number of levels of the output voltage of the inverter, the output waveform has increased number of steps, which produces a staircase wave that approximates to a sinusoidal waveform. Hence, as the level of the output voltage increases, the harmonic distortion of the output wave decreases. As seen from the simulation results, THIPWM have a superior performance compared to SPWM. The SPWM technique is very popular for industrial converters. It is the easiest modulation scheme to understand and implement. This technique can be used in single-phase and three-phase inverters. The THIPWM technique operates by adding a third harmonic component to the sinusoidal modulating wave. It is possible to increase the fundamental by about 15.5% and, hence, allow a better utilization of the DC power supply. From the shape of the line-to-line voltages, the resulting flat-topped waveforms allow over-modulation with respect to the original SPWM technique. Space Vector Modulation technique and Direct Torque Control strategy can be implemented in the cascaded rectifier inverter configuration.

Keywords— Bidirectional Switch, Multilevel Inverter, PWM, Electric Traction, Total Harmonic Distortion.

I. INTRODUCTION

Electric traction drive has now been considered to be an efficient way of transmitting power to the traction motors that can deliver as much as two and half times the tractive power output of equivalent diesel traction. Its high power-to-weight ratio results in faster acceleration and higher tractive effort [1]. It requires medium voltage and high power operation. This can be achieved with the help of multilevel inverters [2]. The traction transformer steps down the centenary voltage to a level convenient for traction motors to improve the efficiency and reliability of the steam traction drive lead to the electrification of the railway system.

A multilevel inverter is a power electronic system that synthesizes a desired output voltage from several levels of dc voltages as inputs. Recently, multilevel power conversion technology has been developing the area of power electronics very rapidly with good potential for further developments. As a result, the most attractive applications of this technology are in the medium to high voltage ranges [3]. Its applications are in the field of high-voltage high-power applications such as laminators, mills, compressors, large induction motor drives, UPS systems, and static var compensation. Its working principle is based on producing small output voltage steps which results in better power quality. They operate at low voltage levels and also at a low switching frequency so that the switching losses are also reduced.

The principle includes as the number of levels in the inverter increases, the output voltage has more step generation i.e. staircase waveform, which has a reduced harmonic distortion.

The multilevel inverter is a promising inverter topology for high voltage and high power applications. This inverter synthesizes several different levels of DC voltages to produce a stepped AC output that approaches the pure sine waveform. It has the advantages like high power quality waveforms, lower voltage ratings of devices, lower harmonic distortion, lower switching frequency and switching losses, higher efficiency, reduction of dv/dt stresses etc. It gives the possibility of working with low speed semiconductor in comparison with the two-level inverters. Numerous of MLI topologies and modulation techniques have been introduced. But most popular MLI topology is Diode Clamped [4], [5] Flying Capacitor [6], [7] and Cascaded Multilevel Inverter (CMLI) [8] - [11].

II. MULTILEVEL INVERTER

Generally conventional multilevel inverters include an array of switching devices and voltage sources which generate voltages with stepped waveform in the output. A cascade multilevel inverter consists of several single-phase full bridge inverters connected in series. The proposed symmetrical topology uses only one dc supply to generate complete three phase output which is a unique achievement over conventional topologies.

Fig. 1 shows a three phase of 7-level symmetrical structure inverter. V_{dc} is the smallest DC - voltage that is equal to step size.

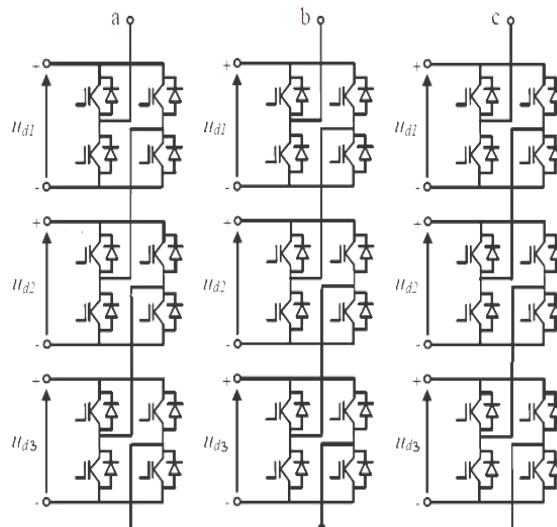

Fig.1.A three phase of 7-level symmetrical inverter

Multilevel Inverter in Traction System The railway electric traction requires high voltage operation. This can be fulfilled by the series or parallel combination of various semi-conductor devices. But because of the differences in their inherent characteristics, it will damage the devices. This limitation can be overcome with the help of multilevel converter [12].

III. MODULATION

With advances in solid-state power electronic devices and microprocessors, various pulse-width-modulation (PWM) techniques have been developed for industrial applications.

The modulation control techniques can be classified into Pulse Width Modulation (PWM), Selective Harmonic Elimination (SHE) Modulation and Optimized Harmonic Stepped Waveform (OHSW) [13]. The PWM technique can be open loop type like sinusoidal PWM, Space Vector Modulation, sigma delta and closed loop type like hysteresis current controller, linear current controller etc. PWM can be considered to be an efficient modulation technique as it does not require additional components, lower harmonics can be eliminated or minimized leaving higher order harmonics which can be easily filtered out. But the requirement of SCRs in this technique with low turn-on and turn-off times makes it expensive.

Sinusoidal Pulse Width Modulation (SPWM) is the simplest technique that can be implemented in both two level and multilevel inverters [14]. Two signals one is a sinusoidal reference signal and other a high frequency carrier signal (triangular signal) is compared to give two states (high or low). The amplitude of the fundamental component of the output voltage of the inverter can be controlled by varying Modulation Index (MI). MI is defined as the ratio of the magnitude of the reference signal (V_r) to that of the magnitude of the carrier signal (V_c). Thus, by keeping V_c constant and varying V_r , the modulation index can be varied.

Multicarrier Pulse Width Modulation Techniques

The carrier based PWM techniques for cascaded multilevel inverter can be broadly classified into: phase shifted modulation and level shifted modulation [15]. In both the techniques, for a m level inverter, $(m-1)$ triangular carrier waves are required. And all the carrier waves should have the same frequency and the same peak to peak magnitude.

Phase Shifted Multicarrier Modulation

In phase shifted PWM (PS-PWM), there is a phase shift ϕ_{cr} between the adjacent carrier signals. The phase shift is given by (1),

$$\Phi_r = \frac{360}{(m-1)} \quad (1)$$

For a three phase inverter, the modulating signals should also be three phase sinusoidal signals with adjustable magnitude and frequency. For this modulation scheme, the frequency modulation index m_f and the amplitude modulation index m_a is given by (2), (3), respectively.

$$m_f = \frac{f_{cr}}{f_m} \quad (2)$$

And,

$$m_a = \frac{v_{mA}}{v_{cr}} \quad (3)$$

Where f_{cr} , f_m are the frequency of the carrier and the modulating signals respectively. are the peak amplitudes V_{cr} , V_m of the carrier and modulating signals respectively. The amplitude modulation lies in the range of 0 to 1. The switching frequency of the device can be calculated as $f_{dev} = f_{cr} \times m_f$. The switching frequency of the inverter can be found from the device switching frequency as $f_{inv} = (m-1) \times f_{dev}$.

Level Shifted Multicarrier Modulation

In Level Shifted PWM (LS -PWM), the triangular waves are vertically displaced such that the bands occupy are contiguous. The frequency modulation is given by $m_f = \frac{f_{cr}}{f_m}$ and amplitude modulation index is $m_a = \frac{V_m}{V_{cr}}$ where f_m and f_{cr} are the frequencies of the modulating and carrier waves and V_m and V_{cr} are the peak amplitudes of modulating and carrier waves respectively. The amplitude modulation lies in the range of 0 to 1. Based on the disposition of the carrier waves, level shifted PWM can be In Phase Disposition PWM (IPD - PWM), Phase Opposition Disposition PWM (POD - PWM) and Alternate Phase Opposition Disposition PWM (APOD -PWM).

IPD PWM

In this modulation, all the triangular carrier waves are in phase.

POD PWM

In this form of modulation, the carrier waveforms are in all phases above and below the zero reference value. However there is 180 degrees phase shift between the ones above and below zero respectively.

APOD -PWM

In this form of modulation, the carrier waves are displaced from each other by 180 degrees alternately. In this modulation, the inverter switching frequency and the device switching frequency are given by and respectively. In LS-PWM, each carrier is associated with the gating signals of NPC converter whereas in PS-PWM, a pair of carriers is associated with each cell of the CHB and FC converters. Because of the phase shifting of the carriers, power is evenly distributed among the cells which results in the smooth operation of CHB and the natural voltage balancing of the FC. Therefore, LS-PWM is mainly used for NPC converter whereas PS-PWM is practically used for CHB and FC converter. Even though IPD PWM results in low THD as compared to PS-PWM, the small difference in the high frequency content can be filtered out [12,16].

IV THIRD HARMONIC INJECTION

The utilization rate of the DC voltage for traditional sinusoidal PWM is only 78.5% of the DC bus voltage, which is far less than that of the six-step wave (100%). Improving the utilization rate of the DC bus voltage has been a research focus in power electronics.

This problem of the under-utilization of the DC bus voltage led to the development of the third-harmonic-injection pulse-width modulation (THIPWM). It is similar to sinusoidal modulation but the difference is that the reference ac waveform is not sinusoidal but consists of both a fundamental component and a third-harmonic component. As a result, the peak-to-peak amplitude of the resulting reference function does not exceed the DC supply voltage V_s , but the fundamental component is higher than the available supply V_s . This is 15% higher in amplitude than that achieved by the sinusoidal PWM. Therefore, the third-harmonic PWM provides better utilization of the dc supply voltage than the sinusoidal PWM does [18].

V. SIMULATION RESULTS

Here simulation is carried out in several cases, in that proposed cascaded multilevel inverter operated under several modulation schemes by using Matlab/Simulink tool.

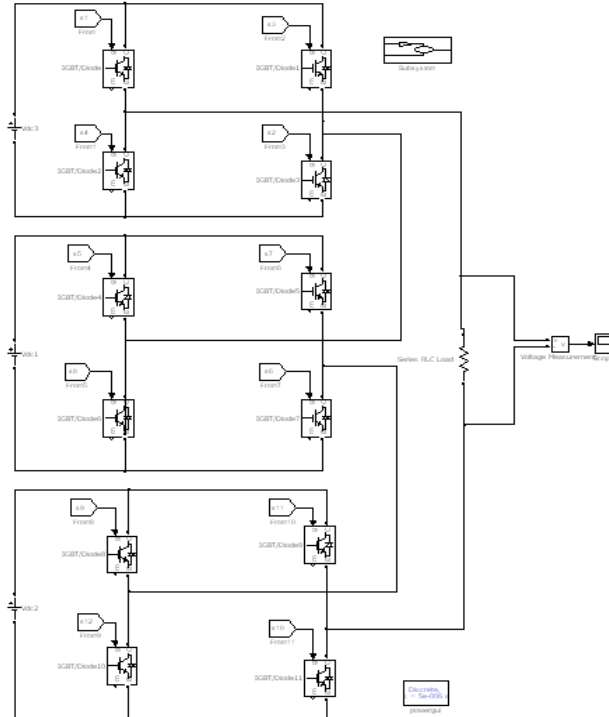

Fig.2 Matlab/Simulink Model of 1-phase symmetrical Cascaded Multilevel Inverter Operated under several modulation techniques

Fig.2 shows the Matlab/Simulink Model of Proposed symmetrical Cascaded Multilevel Inverter Operated under several modulation techniques using matlab/Simulink environment.

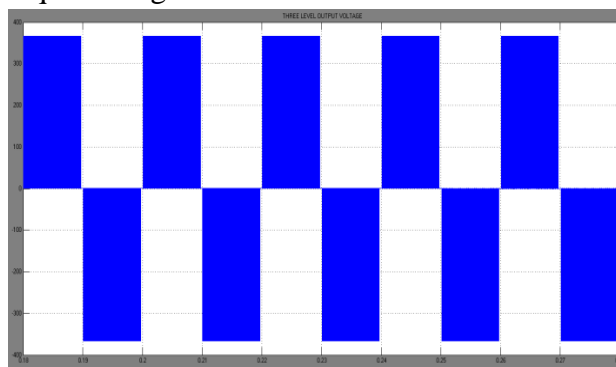

Fig.3 Three level Output Voltage using PSPWM

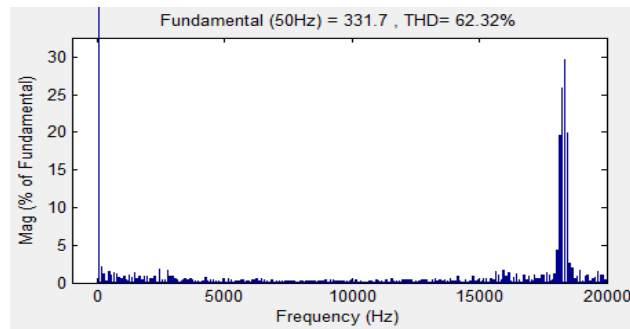

Fig.4 FFT Analysis of 3-level Output Voltage using CHB fed PSPWM

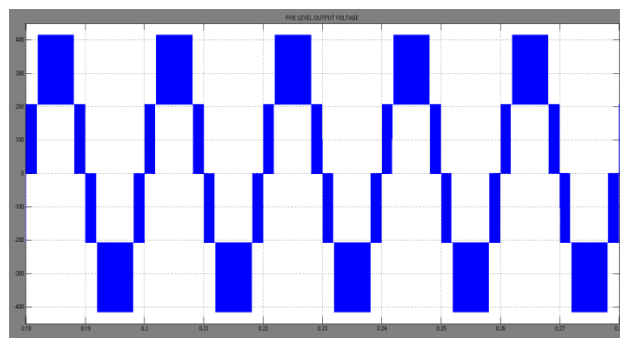

Fig.5-3-Level Output Voltage of CHB Inverter Fed PSPWM

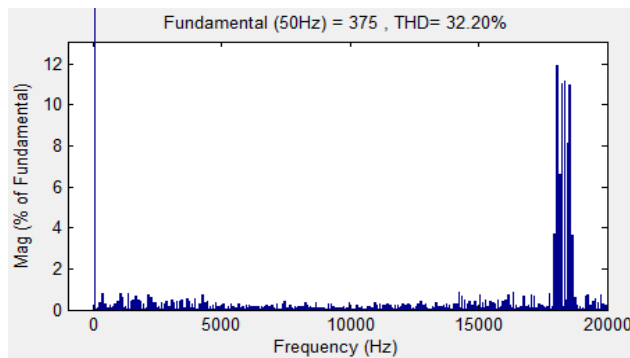

Fig.6 FFT Analysis of 5-level Output Voltage of CHB Inverter Fed PSPWM

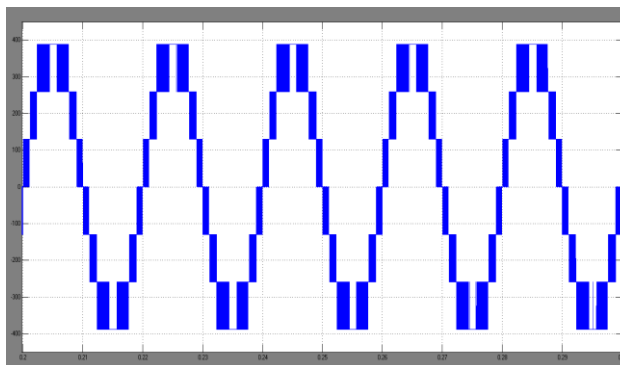

Fig.7 7-Level Output Voltage of CHB Inverter Fed PSPWM

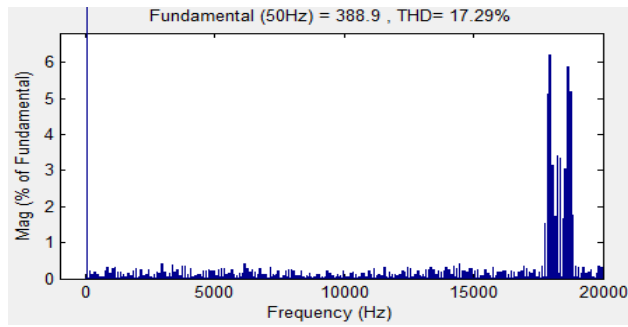

Fig.8 FFT Analysis of 7-level Output Voltage of CHB Inverter Fed PSPWM

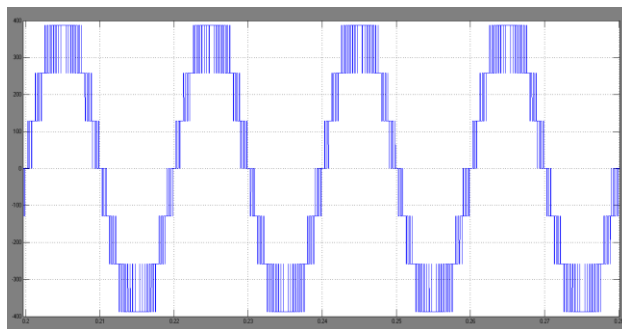

Fig.9 7-Level Output Voltage of CHB Inverter Fed LSPWM-IPD Scheme

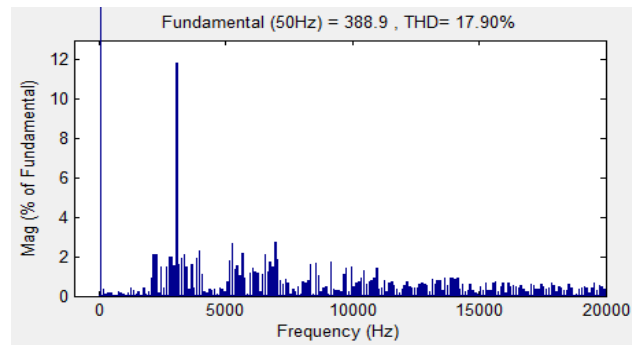

Fig.10 FFT Analysis of 7-level Output Voltage of CHB Inverter Fed LSPWM-IPD Scheme

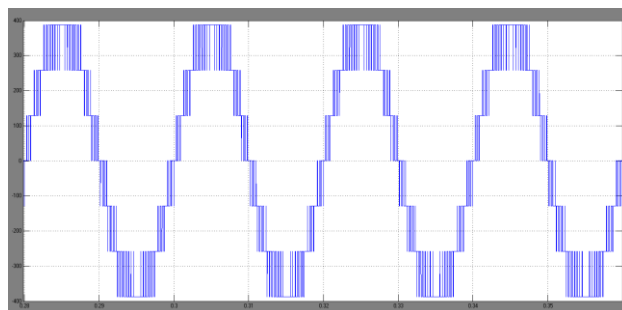

Fig.11 7-Level Output Voltage of CHB Inverter Fed LSPWM-POD Scheme

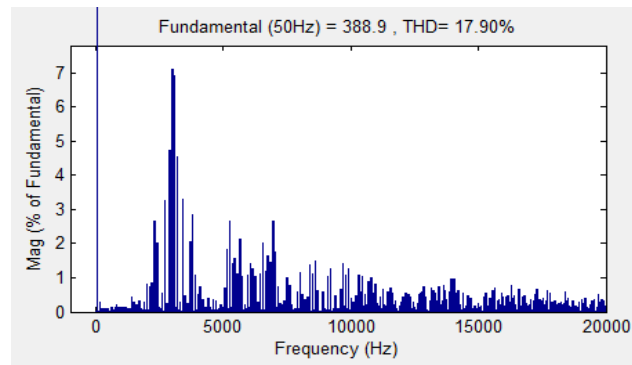

Fig.12 FFT Analysis of 7-level Output Voltage of CHB Inverter Fed LSPWM-POD Scheme attains

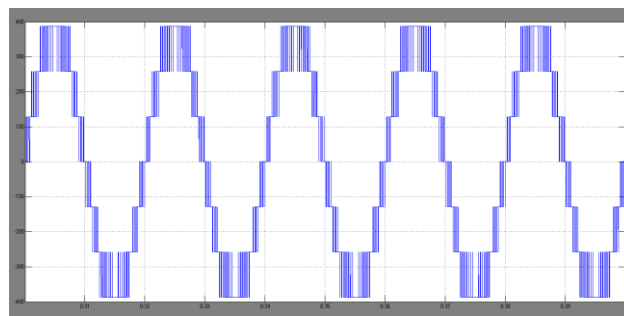

Fig.13 7-Level Output Voltage of CHB Inverter Fed LSPWM-APOD Scheme

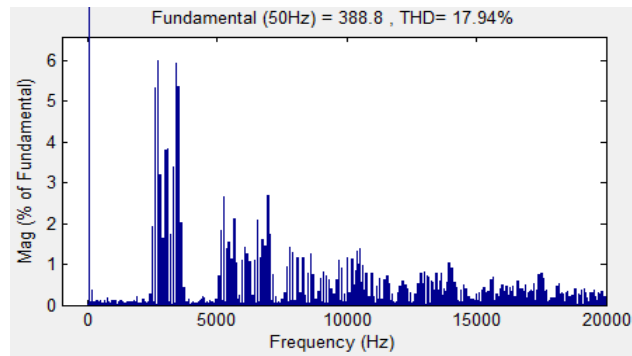

Fig.14 FFT Analysis of 7-level Output Voltage of CHB Inverter Fed LSPWM-APOD Scheme

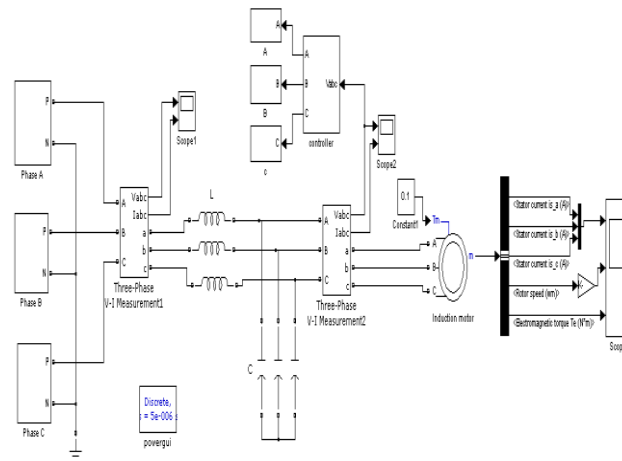

Fig.15 Matlab/Simulink Model of Proposed Three Phase CHB Inverter Fed Induction Machine Drive Operated under LS-PWM Modulation Scheme With Filter & Controller

Fig.15 shows the Matlab/Simulink Model of Proposed Three Phase CHB Inverter Fed Induction Machine Drive Operated under LS-PWM Modulation Scheme using Matlab/Simulink tool.

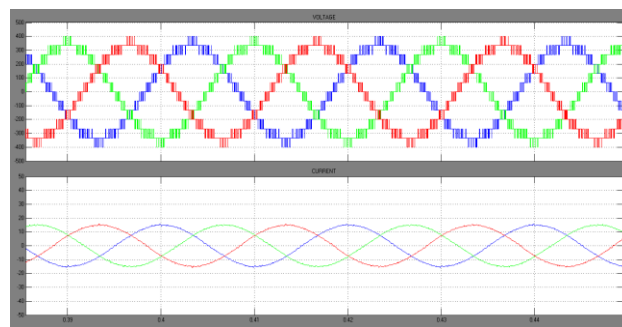

Fig.16 Output Voltage & Current

Fig.16 Output Voltage & Current of Proposed Three Phase CHB Inverter Fed Induction Machine Drive Operated under LSPWM Scheme Before filter.

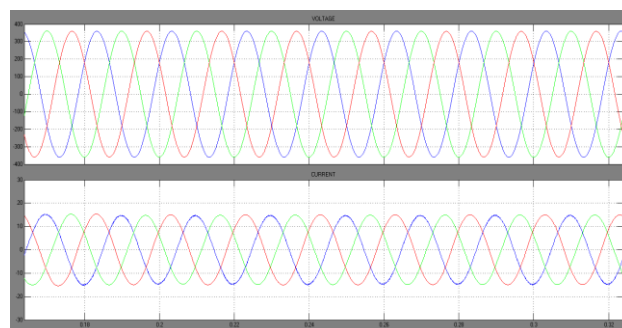

Fig.17 Output Voltage & Current

Fig.17 Output Voltage & Current of Proposed Three Phase CHB Inverter Fed Induction Machine Drive Operated under LSPWM Scheme After filter.

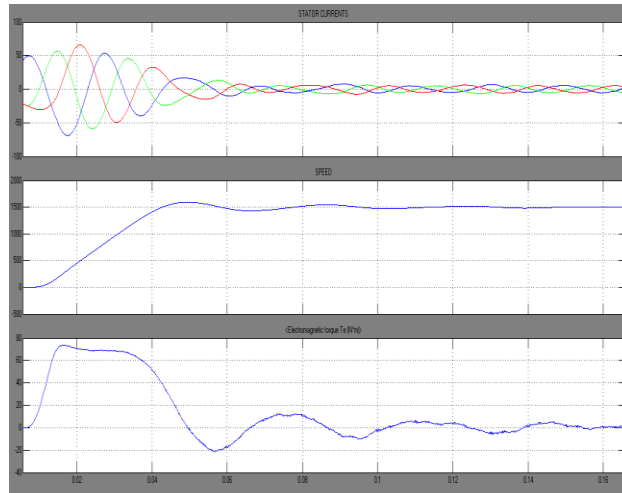

Fig.18 Induction Machine Drive Characteristics

Fig.18 Simulation Results of Proposed Three Phase CHB Inverter Fed Induction Machine Drive Operated under LSPWM Scheme.

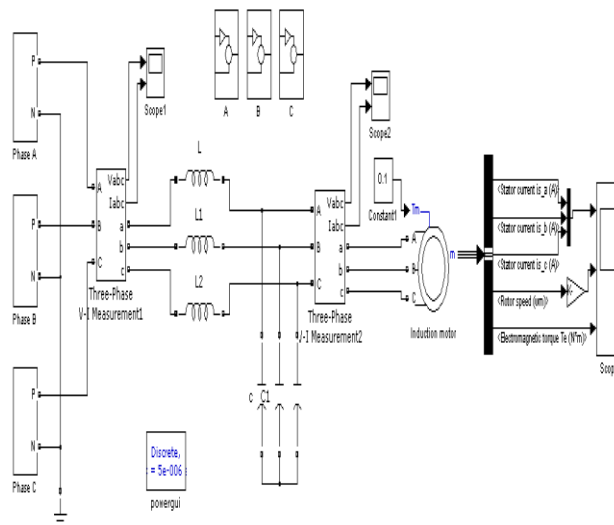

Fig.19 Matlab/Simulink Model of Proposed Three Phase CHB Inverter Fed Induction Machine Drive Operated under THI-PWM Modulation Scheme

Fig.19 shows the Matlab/Simulink Model of Proposed Three Phase CHB Inverter Fed Induction Machine Drive Operated under THI-PWM Modulation Scheme using Matlab/Simulink tool.

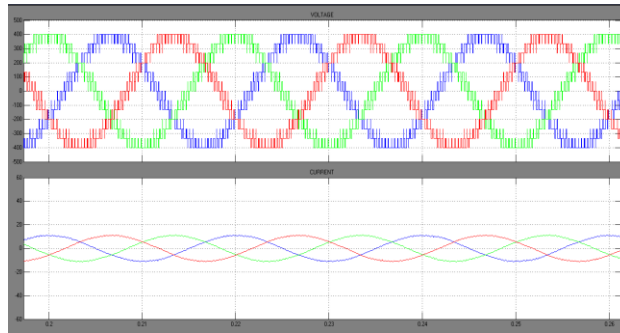

Fig.20 Output Voltage & Current

Fig.20 Output Voltage & Current of Proposed Three Phase CHB Inverter Fed Induction Machine Drive Operated under THIPWM Scheme before filter

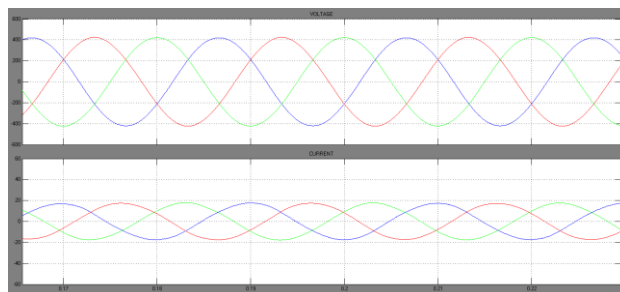

Fig.21 Output Voltage & Current

Fig.21 Output Voltage & Current of Proposed Three Phase CHB Inverter Fed Induction Machine Drive Operated under THIPWM Scheme after filter

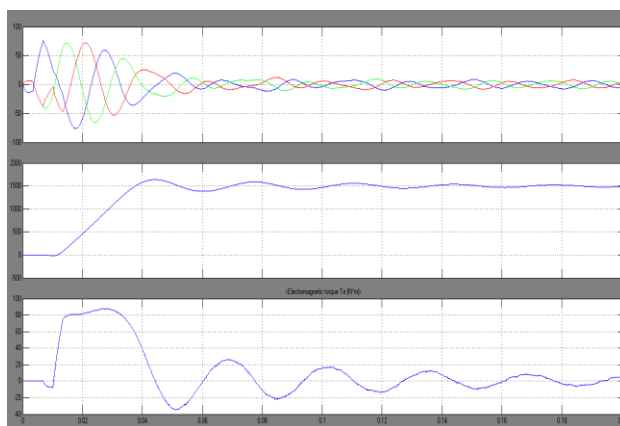

Fig.22 Induction Machine Drive Characteristics

Fig.22 Simulation Results of Proposed Three Phase CHB Inverter Fed Induction Machine Drive Operated under THIPWM Scheme.

V. CONCLUSION

Pulse Width Modulation variable speed drives are increasingly applied in many new industrial applications that require superior performance. Recently, developments in power electronics and semiconductor technology have lead improvements in power electronic systems. This proposed technique provides more flexibility to designers and can generate more voltage levels without losing any level which worsens THD characteristics. The possibility of extension or series connection of this basic in two topologies has been studied. As we increase the number of levels of the output voltage of the inverter, the output waveform has increased number of steps, which produces a staircase wave that approximates to a sinusoidal waveform. Hence, as the level of the output voltage increases, the harmonic distortion of the output wave decreases. As seen from the simulation results, THIPWM have a superior performance compared to SPWM. The SPWM technique is very popular for industrial converters. It is the easiest modulation scheme to understand and implement. This technique can be used in single-phase and three-phase inverters. The THIPWM technique operates by adding a third harmonic component to the sinusoidal modulating wave. It is possible to increase the fundamental by about 15.5% and, hence, allow a better utilization of the DC power supply. From the shape of the line-to-line voltages, the resulting flat-topped waveforms allow over-modulation with respect to the original SPWM technique. Space Vector Modulation technique and Direct Torque Control strategy can be implemented in the cascaded rectifier inverter configuration.

VI. REFERENCES

- [1] H. Portable, Modern Electric Traction, 4th Ed., Dhanpat Rai and Co.,2003, pp. 1-10,65-68.
- [2] S.Kouro, M.Malinowski et. al., "Recent Advances and Industrial Applications of Multilevel Converters", IEEE Transactions on industrial electronics, vol.57, no.8, pp. 2553-2580, Aug 2010.
- [3] L.J. Peng FZ. Multilevel converters – a new breed of power converters. IEEE Trans Ind Appl 1996;32(3):509–17.
- [4] M.Fracchia, T.Ghiara, M. Marchesoni, and M. Mazzucchelli, "Optimized modulation techniques for the generalized N-level converter", in Proc. IEEE Power Elect. Spec. Conf., Madrid, Spain,1992, pp. 1205–1213.
- [5] K. A. Corzine and J. R. Baker, "Reduced parts-count multilevel rectifiers", IEEE Trans. Ind. Electron., Vol. 49, Aug. 2002, pp. 766–774.
- [6] F. Richardeau, P. Baudesson, and T. Meynard, "Failurestolerance and remedial strategies of a PWM multicell inverter", in Proc. IEEE Power Elect. Spec. Conf., Vol. 2, Galway, Ireland, June 2000, pp. 649–654.
- [7] F. Z. Peng, "A generalized multilevel inverter topology with self-voltage balancing", IEEE Trans. Ind. Applicant., Vol. 37, Mar./Apr. 2001, pp.611–618.
- [8] P.W. Hammond, "Medium voltage pwm drive and method," U.S. Patent5 625 545, April 1997.
- [9] F. Z. Peng, J. W. McKeever, and D. J. Adams, "A power line conditioner using cascade multilevel inverters for distribution systems," in Proc. IEEE Ind. Appl. Soc. Conf., Vol. 2, 1997, pp. 1316–1321
- [10] M. D. Manjrekar, P. K. Steimer, and T. A. Lipo, "Hybrid multilevel power conversion system: a competitive solution for high-power applications," IEEE Trans. Ind. Applicat., Vol. 36, May/June 2000, pp.834–841.
- [11] K. A. Corzine and Y. L. Familant, "A new cascaded multilevel H bridge drive", IEEE Trans. Power Elect., Vol. 17, Jan. 2002, pp. 125–131.
- [12] L.G. Franquelo, J.Rodriguez, et. al., "The Age of Multilevel Converters arrives", IEEE Industrial Electronics Magazine, vol. 2, Issue 2, June 2008, pp. 28-39,
- [13] J. Wang and D. Ahmadi, "A Precise and Practical Harmonic Elimination Method for Multilevel Inverters", IEEE Transactions on Industry Applications, vol. 46, no. 2, Mar-Apr 2010, pp. 857-865



-
- [14] S. H. Hosseini, M. Ahmadi, S. Ghassem Zadeh, “Reducing the output harmonics of Cascaded H-bridge Multilevel Inverter for Electric Vehicle Applications” , 8th International Conference on Electrical Engineering/ Electronics, Computer Telecommunications and Information Technology (ECTI-CON 2011), Thailand, May 2011, pp. 752-755, 17-19 .
- [15] B.Wu, High Power Converters and AC Drives, IEEE Press, Wiley-Interscience, A John Wiley and Sons Inc., Publications, 2006.
- [16] V. Naga Bhaskar Reddy, V. Narasimhulu, Dr. Ch. Sai Babu, “Control of Cascaded Multilevel Inverter by using carrier based PWM technique and implemented to Induction Motor drive,” International Journal on Automatic Control and System Engineering (ICGST-ACSE Journal), vol. 10, Issue 1, Dec 2010.
- [17] Hidenori Shigeeda , Akinobu Okui and Hirofumi Akagi “Harmonic analysis of the output voltage of a third-harmonic-injected inverter for LSM drives,”Article first published online: 13 APR 2007DOI: 10.1002/ej.20291